

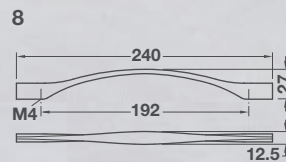

Contemporary

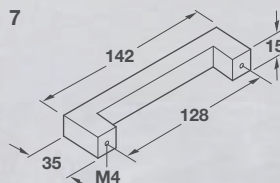

	Finish	Material	A	C	Item No.	SRP/pc.
1	matt	Stainless Steel	107	96	155.01.450	\$19.38
2	matt	Stainless Steel	144	128	155.01.451	\$31.98
3	matt	Stainless Steel	181	160	155.01.452	\$26.59
4	matt	Stainless Steel	218	192	155.01.453	\$30.14
5	matt	Stainless Steel	25	-	134.81.617	\$17.07
6	matt	Stainless Steel	32	-	134.81.626	\$21.92
7	stainless steel look	Zinc	-	-	110.22.001	\$28.12
8	polished chrome	Zinc	-	-	113.96.237	\$27.24

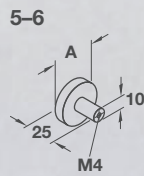
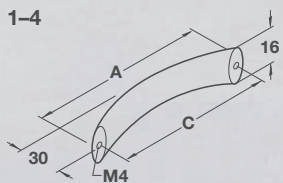

Dimensions in mm unless otherwise noted. Prices subject to change.



Contemporary



	Finish	Material	A	C	Item No.	SRP/pc.
1	polished chrome	Steel	376	306	155.00.811	\$10.49
2	polished chrome	Steel	526	456	155.00.813	\$13.73
3	polished chrome	Steel	828	758	155.00.816	\$18.06
4	polished chrome	Steel	226	156	155.00.810	\$6.37
5	polished chrome	Steel	168	128	155.00.361	\$4.90
6	polished chrome	Steel	136	96	155.00.360	\$4.81

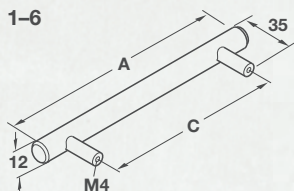



Contemporary



	Finish	Material	A	C	Item No.	SRP/pc.
1	matt nickel	Steel	298	288	155.00.956	\$16.26
2	matt nickel	Steel	202	192	155.00.954	\$11.16
3	matt nickel	Steel	170	160	155.00.953	\$9.33
4	polished chrome	Steel	138	128	155.00.932	\$5.41
5	polished chrome	Steel	106	96	155.00.931	\$4.81
6	satin chrome	Brass	110	4"	116.39.464	\$9.13
7	oil-rubbed bronze	Zinc	-	-	134.45.110	\$2.77
8	oil-rubbed bronze	Zinc	-	-	120.61.350	\$3.06
9	dark oil-rubbed bronze	Zinc	-	-	134.35.320	\$5.74

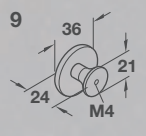
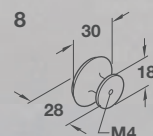
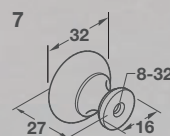
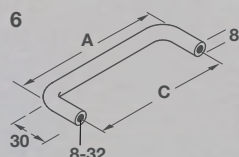
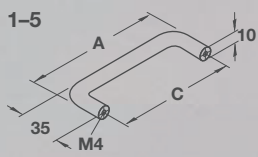



Contemporary



	Finish	Material	A	B	C	D	Item No.	SRP/pc.
1	brushed nickel	Aluminum	139	-	128	-	155.02.025	\$9.56
2	brushed nickel	Aluminum	171	-	160	-	155.02.030	\$10.49
3	matt black	Aluminum	139	-	128	-	155.02.027	\$9.49
4	matt black	Aluminum	171	-	160	-	155.02.032	\$10.53
5	matt black	Zinc	136	27	128	10	116.22.343	\$10.72
6	matt black	Zinc	104	25	96	9	116.22.334	\$9.51
7	matt nickel	Zinc	136	27	128	10	116.22.647	\$10.72
8	matt nickel	Zinc	104	25	96	9	116.22.638	\$9.51

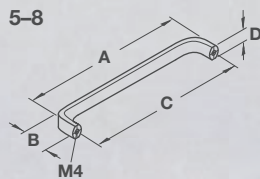
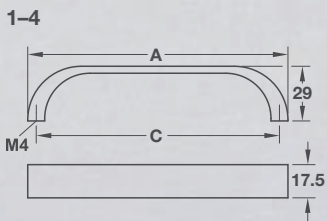

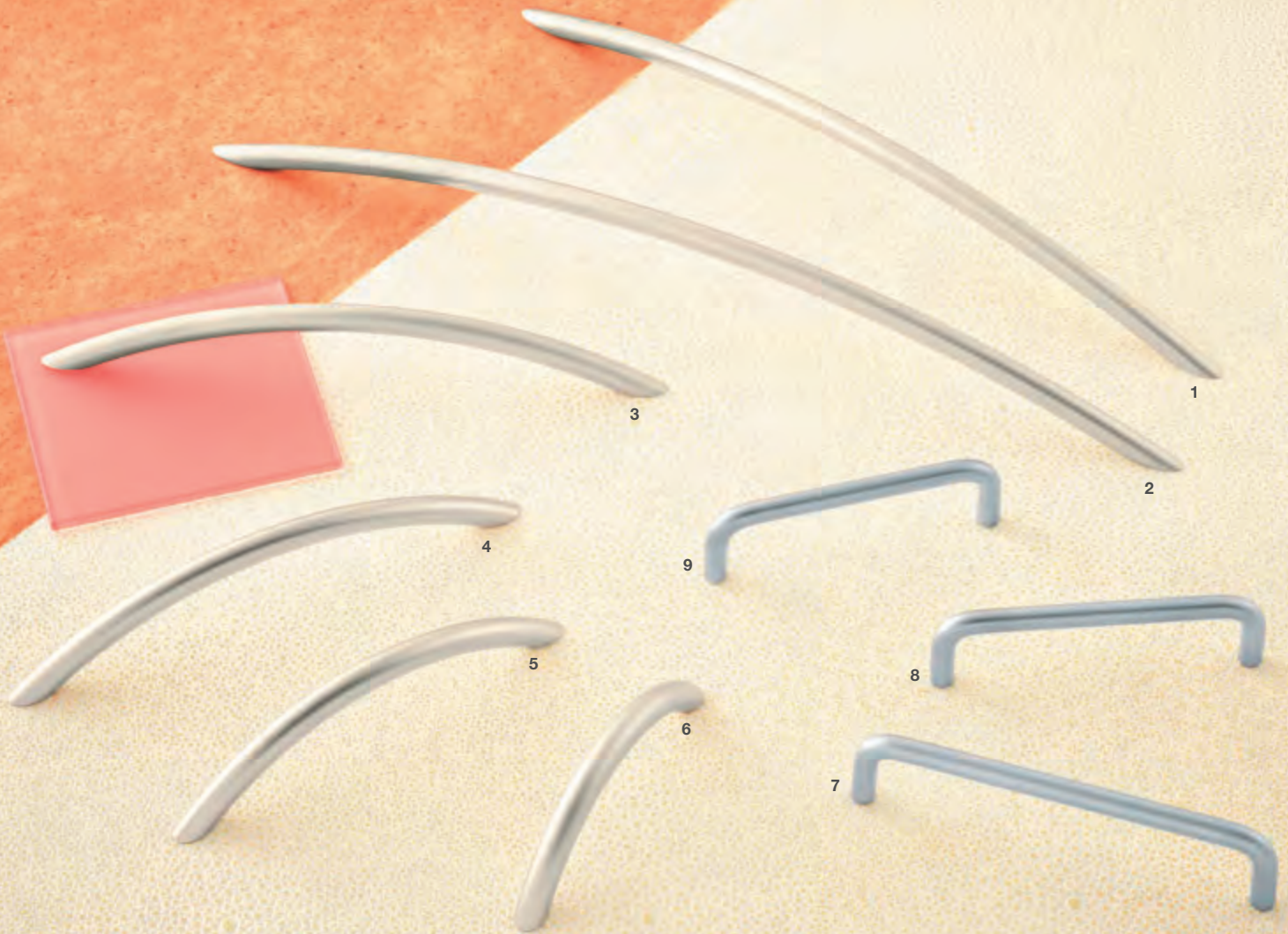

Contemporary



	Finish	Material	A	B	C	Item No.	SRP/pc.
1	matt nickel	Steel	332	31	288	155.00.845	\$16.02
2	matt nickel	Steel	392	41	352	155.00.846	\$19.54
3	matt nickel	Steel	221	32	192	155.00.843	\$11.08
4	matt nickel	Steel	184	32	160	155.00.842	\$9.78
5	matt nickel	Steel	148	30	128	155.00.841	\$7.85
6	matt nickel	Steel	112	30	96	155.00.840	\$7.04
7	satin chrome	Steel	135	-	5"	116.07.443	\$2.36
8	satin chrome	Steel	110	-	4"	116.07.427	\$1.88
9	satin chrome	Steel	97	-	3.5"	116.07.418	\$1.89

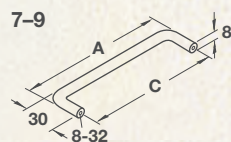
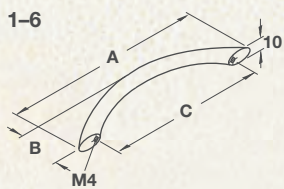

Note
Supplied with 1" mounting screws.



Contemporary



	Finish	Material	A	B	C	Item No.	SRP/pc.
1	stainless steel look	Zinc	81	29	64	155.00.490	\$2.02
2	stainless steel look	Zinc	112	24	96	155.00.491	\$2.98
3	stainless steel look	Zinc	155	30	128	155.00.492	\$4.95
4	stainless steel look	Zinc	203	30	160	155.00.493	\$6.89
5	stainless steel look	Zinc	286	33	224	155.00.494	\$12.19

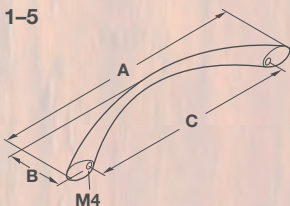



Contemporary



	Finish	Material	A	C	Item No.	SRP/pc.
1	matt chrome	Steel	104	96	116.07.423	\$2.03
2	matt chrome	Steel	110	4"	116.07.426	\$2.03
3	matt nickel	Steel	104	96	116.07.624	\$1.87
4	matt nickel	Steel	110	4"	116.07.627	\$1.95
5	polished chrome	Steel	-	-	155.00.891	\$1.58
6	brushed nickel	Steel - hollow	-	-	134.41.001	\$1.84
7	matt black	Plastic	-	-	136.75.300	\$1.31

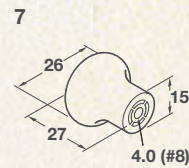
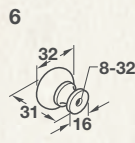
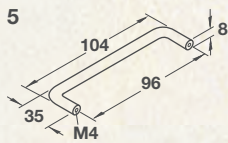
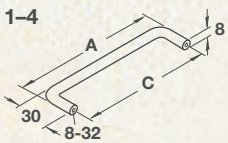

Note
Supplied with 1" mounting screws.

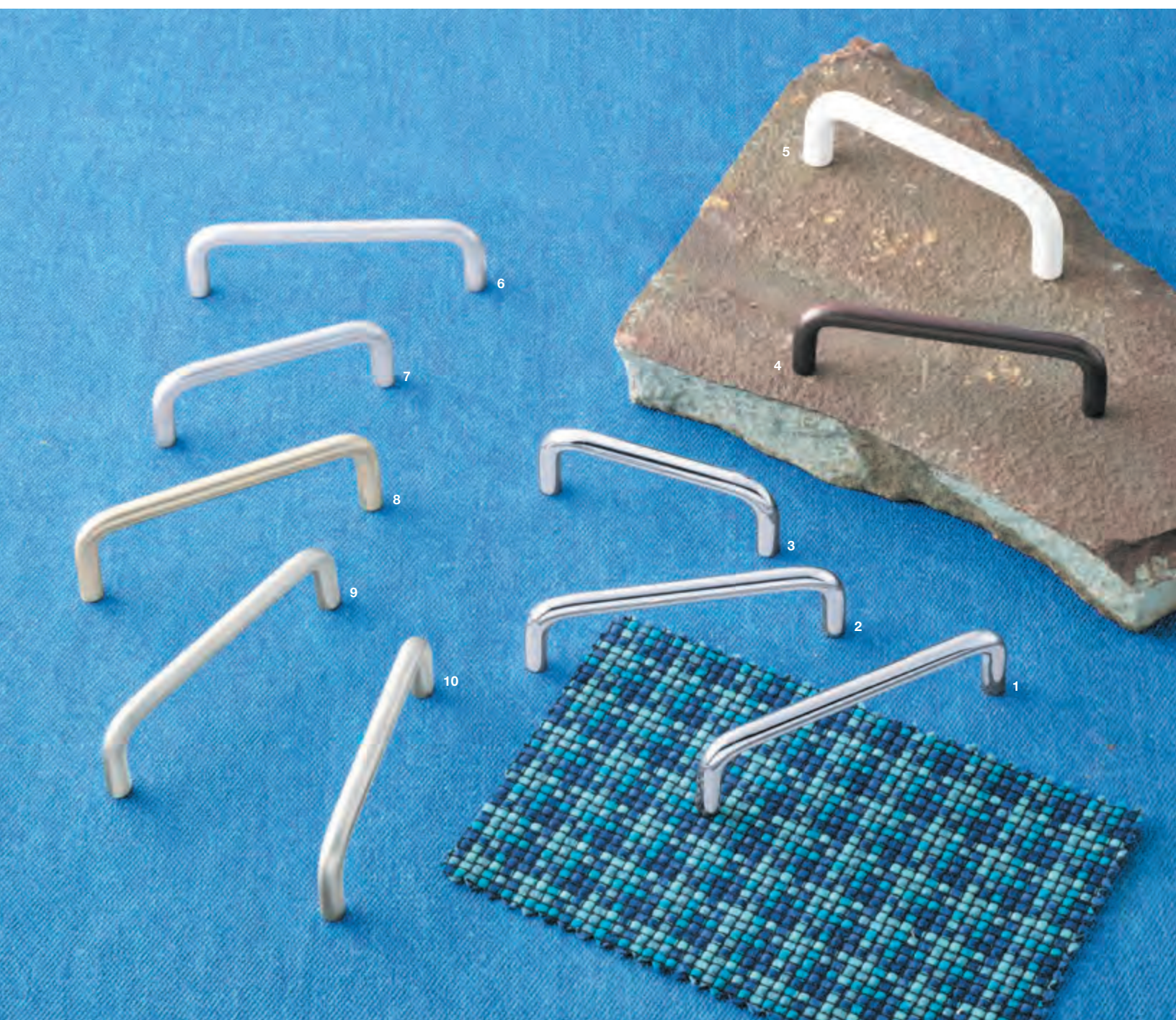

Contemporary



	Finish	Material	A	C	Item No.	SRP/pc.
1	polished chrome	Steel	110	4"	116.07.227	\$1.88
2	polished chrome	Steel	104	96	116.07.224	\$1.87
3	polished chrome	Steel	84	3"	116.07.217	\$1.73
4	satin bronzed copper	Steel	104	96	116.07.118	\$1.88
5	white	Nylon	-	-	116.71.100	\$0.78
6	satin chrome	Steel	104	96	116.07.424	\$2.03
7	satin chrome	Steel	84	3"	116.07.417	\$1.81
8	matt nickel	Steel	-	-	155.00.911	\$2.17
9	stainless steel look	Steel	-	-	155.00.921	\$1.70
10	matt chrome	Steel	-	-	155.00.901	\$1.64

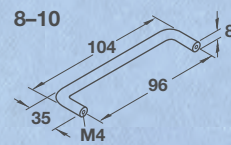
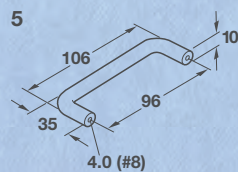
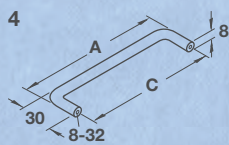
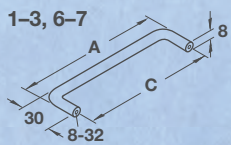

Note
Supplied with 1" mounting screws.

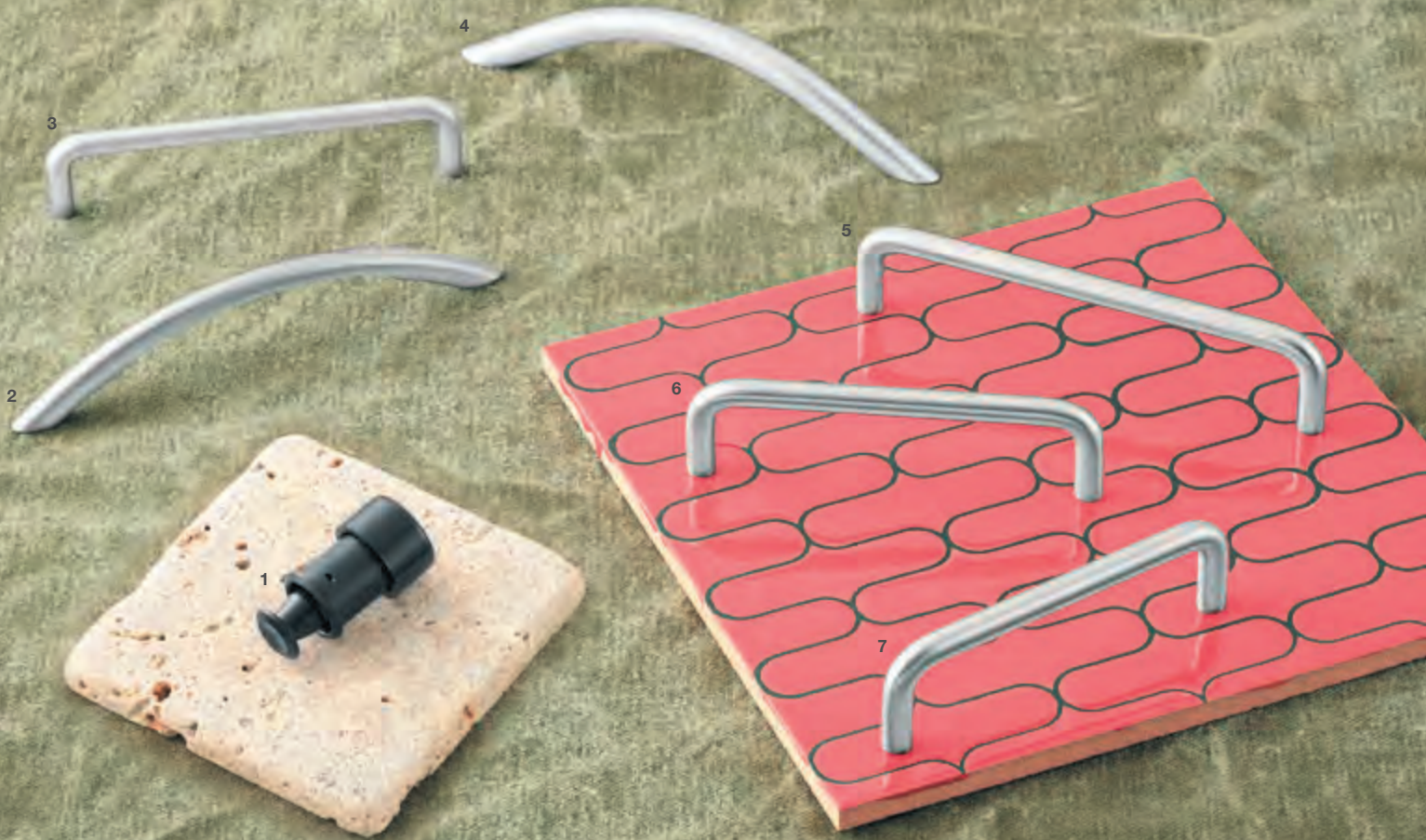

Contemporary *NEW

	Finish	Material	A	C	Item No.	SRP/pc.
1	matt black	Plastic	-	-	138.69.353	\$9.83
2	stainless steel look	Zinc	-	-	103.84.632	\$21.72
3	matt nickel	Steel	-	-	116.07.631	\$12.99
4	matt aluminum	Aluminum	-	-	117.67.955	\$22.00
5*	matt	Stainless Steel 304	136	128	116.10.069	\$4.28
6*	matt	Stainless Steel 304	110	4"	116.10.067	\$4.14
7*	matt	Stainless Steel 304	104	96	116.10.068	\$4.03

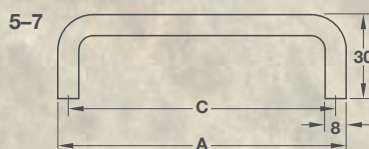
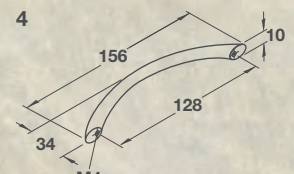
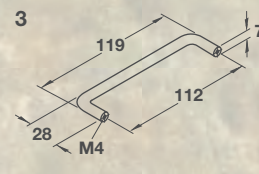
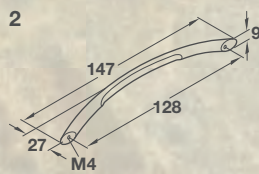
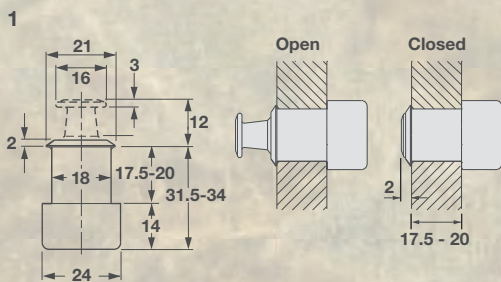



Westin

	Finish	Material	A	C	Item No.	SRP/pc.
1	stainless steel	Aluminum	136	96	112.83.000	\$28.72
2	matt aluminum	Aluminum	168	128	112.83.902	\$24.74
3	stainless steel	Aluminum	200	160	112.83.003	\$34.16
4	matt aluminum	Aluminum	232	192	112.83.904	\$30.86
5	stainless steel	Aluminum	300	260	112.83.006	\$44.08
6	matt aluminum	Aluminum	1000	960	112.83.911	\$88.28
7	stainless steel	Aluminum	500	460	112.83.010	\$59.14
8	matt aluminum	Aluminum	400	360	112.83.909	\$43.26

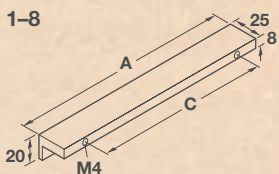



Westin

	Finish	Material	A	C	Item No.	SRP/pc.
1	matt aluminum	Aluminum	300	260	112.83.906	\$35.38
2	stainless steel	Aluminum	400	360	112.83.009	\$49.62
3	matt aluminum	Aluminum	500	460	112.83.910	\$47.12
4	stainless steel	Aluminum	1000	960	112.83.015	\$102.30
5	stainless steel	Aluminum	232	192	112.83.004	\$36.40
6	matt aluminum	Aluminum	200	160	112.83.903	\$27.68
7	stainless steel	Aluminum	168	128	112.83.002	\$31.18
8	matt aluminum	Aluminum	136	96	112.83.900	\$20.80

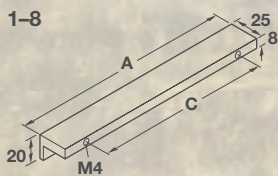

Dimensions in mm unless otherwise noted. Prices subject to change.



Contemporary

	Finish	Material	A	C	Item No.	SRP/pc.
1-2	matt	Stainless Steel	158	128	106.74.602	\$35.62
2	matt	Stainless Steel	240	210	106.74.613	\$40.80
3	matt chrome	Steel & Zinc	168	128	117.26.400	\$45.06
4	matt chrome	Steel & Zinc	264	224	117.25.401	\$49.12
5	polished chrome	Zinc	-	-	109.50.205	\$36.34
6	stainless steel look	Zinc	-	-	155.00.591	\$4.13

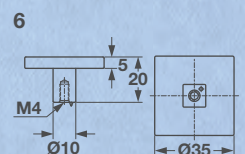
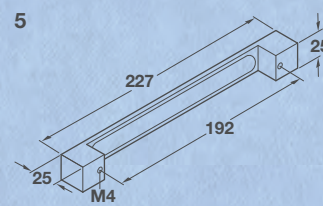
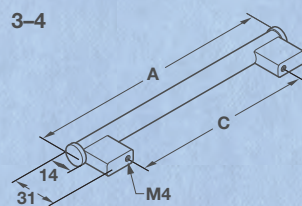
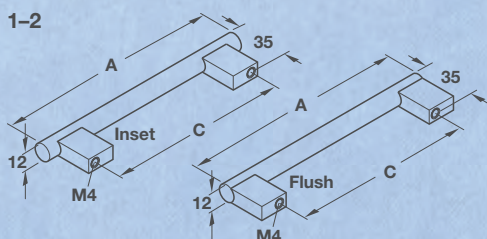



Contemporary

	Finish	Material	A	C	Item No.	SRP/pc.
1	black texture	Zinc	-	-	117.28.331	\$9.44
2	matt black	Steel	-	-	116.09.340	\$9.04
3	matt nickel, antimicrobial	Steel	-	-	116.07.664	\$10.61
4	matt aluminum	Aluminum	234	224	116.05.959	\$10.29
5	matt aluminum	Aluminum	138	128	116.05.931	\$6.59
6	matt aluminum	Aluminum	106	96	116.05.922	\$6.40
7	satin nickel	Zinc	-	-	102.36.600	\$14.14

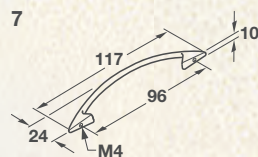
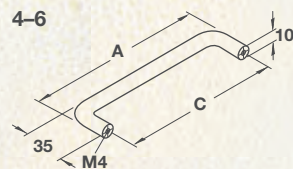
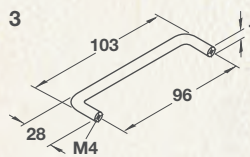
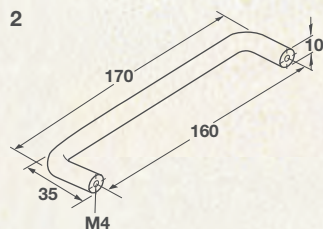
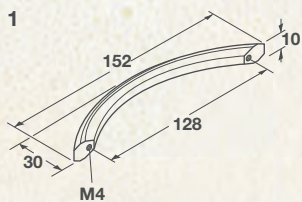

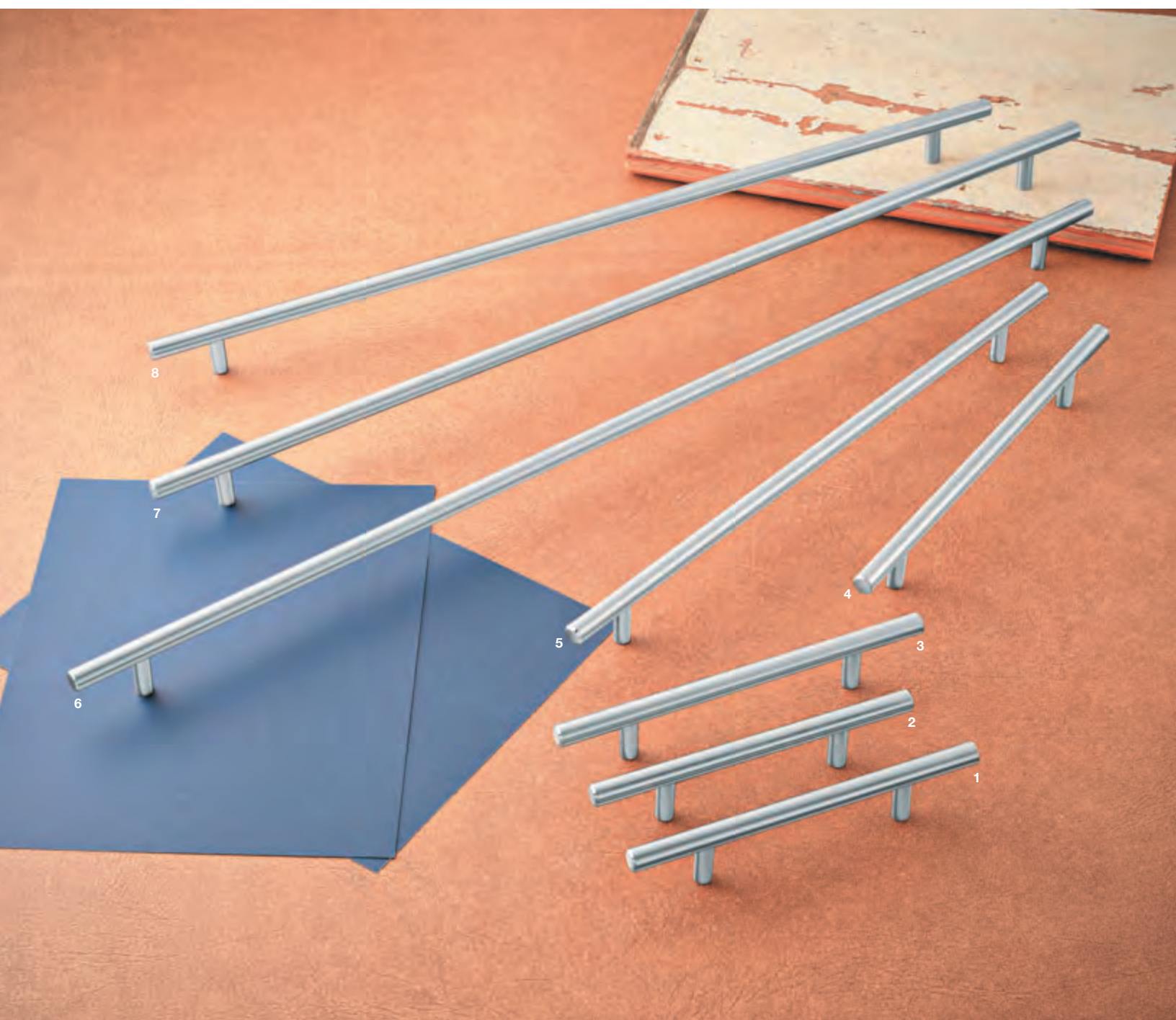

Contemporary

	Finish	Material	A	C	Item No.	SRP/pc.
1	stainless steel look	Steel	188	108	101.20.752	\$5.94
2	stainless steel look	Steel	176	96	101.20.751	\$4.98
3	stainless steel look	Steel	208	128	101.20.753	\$7.39
4	stainless steel look	Steel	272	192	101.20.754	\$7.66
5	stainless steel look	Steel	413	333	101.20.755	\$10.71
6	stainless steel look	Steel	718	638	101.20.758	\$21.06
7	stainless steel look	Steel	642	562	101.20.757	\$15.73
8	stainless steel look	Steel	566	486	101.20.756	\$16.29

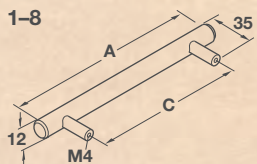



Contemporary

	Finish	Material	Item No.	SRP/pc.
1	matt nickel	Zinc	107.20.603	\$5.28
2	black matt	Zinc	107.20.303	\$6.48
3	polished chrome	Zinc	116.22.236	\$8.95
4	polished chrome	Brass	116.39.259	\$8.54
5	stainless steel	Zinc	117.14.620	\$5.88
6	satin chrome	Metal	134.43.401	\$5.15
7	stainless steel look	Metal	134.43.601	\$5.37
8	matt chrome	Metal	134.43.404	\$6.67
9	stainless steel	Brass - hollow	134.46.609	\$6.61

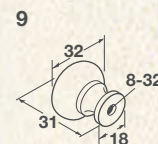
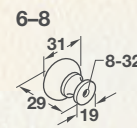
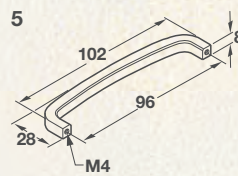
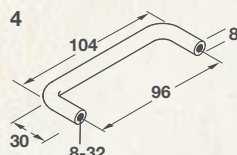
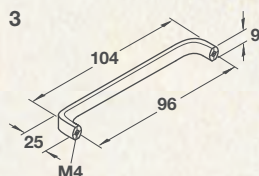
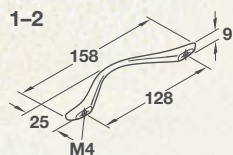

Dimensions in mm unless otherwise noted. Prices subject to change.

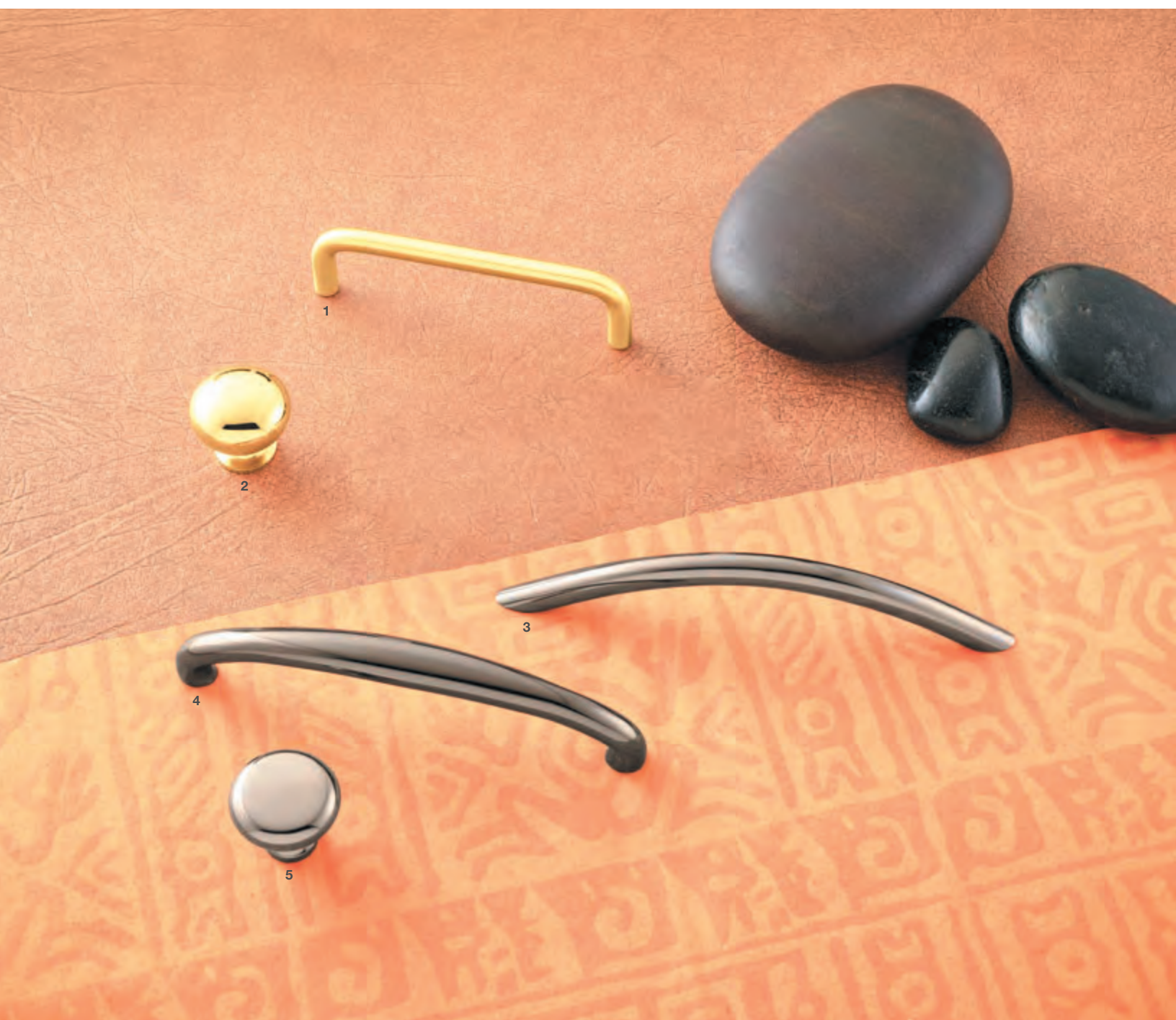

Contemporary

	Finish	Material	Item No.	SRP/pc.
1	satin	Brass	116.39.553	\$7.05
2	polished brass	Metal	134.43.801	\$6.13
3	black nickel	Steel	117.31.936	\$10.15
4	black nickel	Zinc	104.35.310	\$9.76
5	black nickel	Zinc	134.45.308	\$3.09

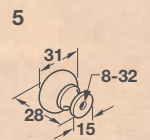
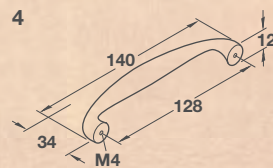
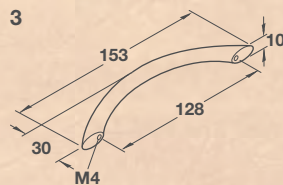
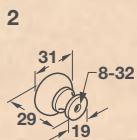
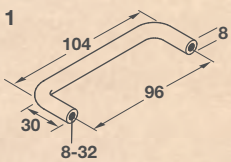

Note
Supplied with mounting screws.



Contemporary

	Finish	Material	A	C	Item No.	SRP/pc.
1	oil-rubbed bronze	Steel	-	-	116.09.324	\$4.16
2	dark oil-rubbed bronze	Steel	104	96	116.07.323	\$3.14
3	dark oil-rubbed bronze	Steel	110	4"	116.07.333	\$3.25
4	stainless steel look	Steel	84	3"	116.07.017	\$1.81
5	stainless steel look	Steel	97	3.5"	116.07.018	\$1.89
6	stainless steel look	Steel	104	96	116.07.024	\$2.54
7	stainless steel look	Steel	110	4"	116.07.027	\$2.54
8	stainless steel look	Steel	135	5"	116.07.043	\$2.31
9	polished chrome	Metal	-	-	134.43.201	\$5.35
10	dark oil-rubbed bronze	Metal	-	-	134.43.331	\$5.79

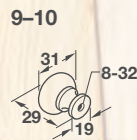
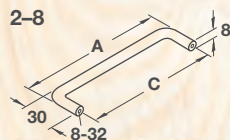
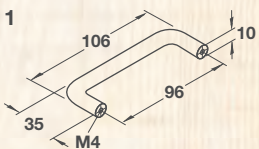

Note
Supplied with mounting screws.



Tempest NEW

	Finish	Material	A	C	Item No.	SRP/pc.
1	matt gold	Aluminum	-	-	110.52.440	\$17.28
2	matt black	Aluminum	-	-	110.52.441	\$17.28
3	dark bronze	Aluminum	-	-	110.52.442	\$17.28
4	matt gold	Aluminum	104	64	110.52.450	\$19.75
5	matt black	Aluminum	104	64	110.52.451	\$19.75
6	dark bronze	Aluminum	104	64	110.52.452	\$19.75
7	matt gold	Aluminum	168	128	110.52.460	\$22.22
8	matt black	Aluminum	168	128	110.52.461	\$22.22
9	dark bronze	Aluminum	168	128	110.52.462	\$22.22

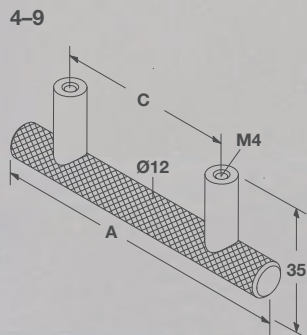
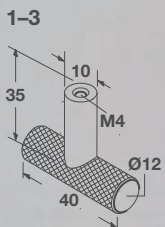

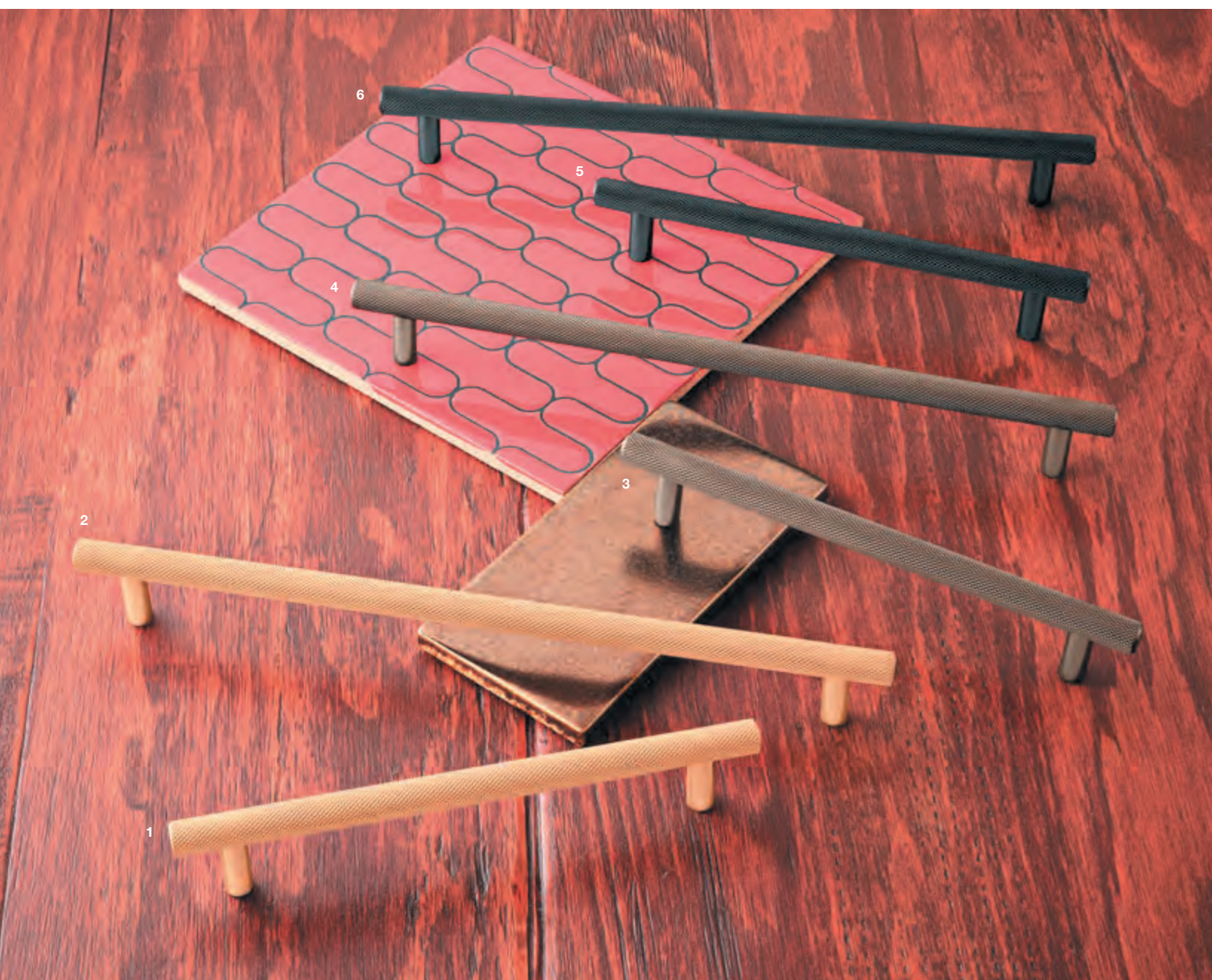

Tempest **NEW**

	Finish	Material	A	C	Item No.	SRP/pc.
1	matt gold	Aluminum	200	160	110.52.470	\$24.72
2	matt gold	Aluminum	296	256	110.52.480	\$37.06
3	dark bronze	Aluminum	200	160	110.52.472	\$24.72
4	dark bronze	Aluminum	296	256	110.52.482	\$37.06
5	matt black	Aluminum	200	160	110.52.471	\$24.72
6	matt black	Aluminum	296	256	110.52.481	\$37.06

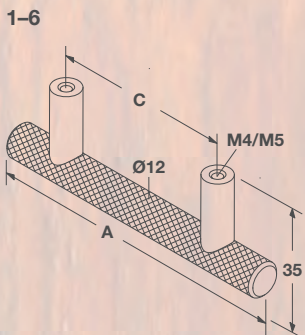

Dimensions in mm unless otherwise noted. Prices subject to change.



Bar Pulls

BY AMEROCK

	Finish	Material	A	C	Item No.	SRP/pc.
1	gold champagne	Steel	137	76 (3")	133.50.662	\$14.20
2	black bronzed	Steel	252	192	133.53.052	\$23.66
3	gold champagne	Steel	337	256	133.50.659	\$24.86
4	black bronzed	Steel	400	320	133.53.047	\$29.62
5	gold champagne	Steel	560	480	133.50.661	\$35.52
6	gold champagne	Steel	156	96	133.50.663	\$15.94
7	black bronzed	Steel	156	96	133.53.050	\$15.94
8	black bronzed	Steel	-	-	133.53.046	\$11.82

Note
Supplied with 1" mounting screws. Refer to page 269 for matching appliance pulls.

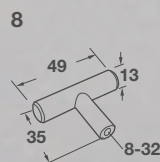
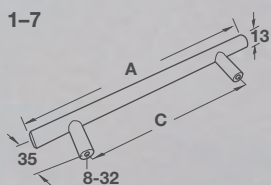



Bar Pulls

BY AMEROCK

	Finish	Material	A	C	Item No.	SRP/pc.
1	gold champagne	Steel	187	128	133.50.657	\$17.76
2	black bronzed	Steel	187	128	133.53.051	\$19.53
3	black bronzed	Steel	337	256	133.53.053	\$27.60
4	gold champagne	Steel	400	320	133.50.660	\$26.62
5	black bronzed	Steel	560	480	133.53.048	\$39.46
6	gold champagne	Steel	252	192	133.50.658	\$21.28
7	black bronzed	Steel	137	76 (3")	133.53.049	\$14.20
8	gold champagne	Steel	-	-	133.50.678	\$10.64

Note

Supplied with 1" mounting screws. Refer to page 269 for matching appliance pulls.

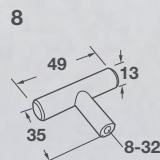
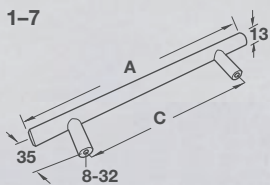

Dimensions in mm unless otherwise noted. Prices subject to change.



Bar Pulls

BY AMEROCK

	Finish	Material	A	C	Item No.	SRP/pc.
1	gunmetal	Steel	400	320	133.50.667	\$26.62
2	polished nickel	Steel	560	480	133.50.675	\$35.52
3	gunmetal	Steel	252	192	133.50.665	\$21.28
4	polished nickel	Steel	337	256	133.50.673	\$24.86
5	polished nickel	Steel	187	128	133.50.671	\$19.53
6	gunmetal	Steel	156	96	133.50.670	\$15.94
7	polished nickel	Steel	156	96	133.50.677	\$15.94
8	gunmetal	Steel	-	-	133.50.679	\$10.64

Note

Supplied with 1" mounting screws. Refer to page 269 for matching appliance pulls.

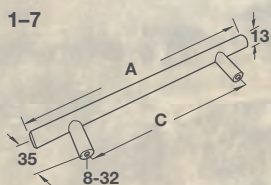



Bar Pulls

BY AMEROCK

	Finish	Material	A	C	Item No.	SRP/pc.
1	gunmetal	Steel	137	76 (3")	133.50.669	\$14.20
2	gunmetal	Steel	187	128	133.50.664	\$19.53
3	gunmetal	Steel	337	256	133.50.666	\$24.86
4	gunmetal	Steel	560	480	133.50.668	\$35.52
5	polished nickel	Steel	400	320	133.50.674	\$26.62
6	polished nickel	Steel	252	192	133.50.672	\$21.28
7	polished nickel	Steel	137	76 (3")	133.50.676	\$14.20
8	polished nickel	Steel	-	-	133.50.680	\$10.64

Note

Supplied with 1" mounting screws. Refer to page 269 for matching appliance pulls.

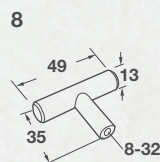
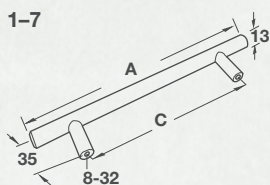

Dimensions in mm unless otherwise noted. Prices subject to change.



Riva

BY AMEROCK

ADA 3-4

	Finish	Material	A	C	Item No.	SRP/pc.
1	satin nickel	Zinc	92	76 (3")	133.53.019	\$12.32
2	satin nickel	Zinc	113	96	133.50.711	\$14.08
3	satin nickel	Zinc	144	128	133.53.020	\$15.84
4	satin nickel	Zinc	178	160	133.53.021	\$17.59

Note

Supplied with mounting screws.

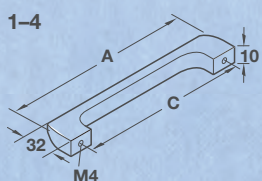



Rift **NEW**

BY AMEROCK

ADA

	Finish	Material	A	C	Item No.	SRP/pc.
1	satin nickel	Zinc	108	96	133.53.513	\$10.57
2	satin nickel	Zinc	140	128	133.53.514	\$14.06
3	polished chrome	Zinc	108	96	133.53.455	\$10.57
4	polished chrome	Zinc	140	128	133.53.456	\$14.06
5	matt black	Zinc	108	96	133.53.402	\$10.57
6	matt black	Zinc	140	128	133.53.403	\$14.06

Note
Supplied with mounting screws.

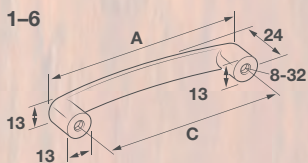

Dimensions in mm unless otherwise noted. Prices subject to change.



Caliber NEW

BY AMEROCK

Finish	Material	Item No.	SRP/pc.
1 polished chrome	Zinc	133.53.440	\$17.59
2 satin nickel	Zinc	133.53.494	\$15.85
3 champagne bronze	Zinc	133.53.323	\$15.85
4 matt black	Zinc	133.53.383	\$15.85
5 champagne bronze	Zinc	133.53.328	\$42.29
6 satin nickel	Zinc	133.53.499	\$42.29
7 polished chrome	Zinc	133.53.445	\$42.29
8 matt black	Zinc	133.53.388	\$42.29

Note
Supplied with mounting screws.

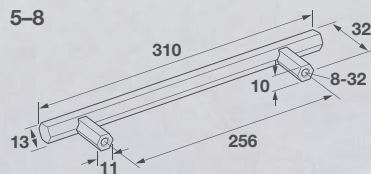
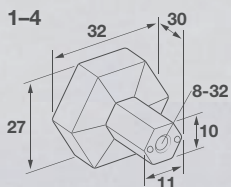



Caliber NEW

BY AMEROCK

	Finish	Material	A	C	Item No.	SRP/pc.
1	polished chrome	Zinc	149	96	133.53.441	\$21.11
2	polished chrome	Zinc	181	128	133.53.442	\$28.18
3	polished chrome	Zinc	214	160	133.53.443	\$31.73
4	polished chrome	Zinc	246	192	133.53.444	\$35.21
5	champagne bronze	Zinc	149	96	133.53.324	\$17.28
6	champagne bronze	Zinc	181	128	133.53.325	\$25.34
7	champagne bronze	Zinc	214	160	133.53.326	\$28.56
8	champagne bronze	Zinc	246	192	133.53.327	\$35.21

Note
Supplied with mounting screws.

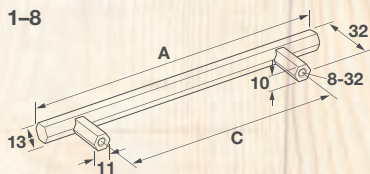

Dimensions in mm unless otherwise noted. Prices subject to change.



Caliber NEW

BY AMEROCK

	Finish	Material	A	C	Item No.	SRP/pc.
1	matt black	Zinc	149	96	133.53.384	\$18.99
2	matt black	Zinc	181	128	133.53.385	\$25.34
3	matt black	Zinc	214	160	133.53.386	\$28.56
4	matt black	Zinc	246	192	133.53.387	\$35.21
5	satin nickel	Zinc	149	96	133.53.495	\$18.99
6	satin nickel	Zinc	181	128	133.53.496	\$25.34
7	satin nickel	Zinc	214	160	133.53.497	\$28.56
8	satin nickel	Zinc	246	192	133.53.498	\$35.21

Note
Supplied with mounting screws.

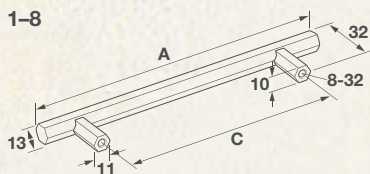



Radius **NEW**

BY AMEROCK

	Finish	Material	A	C	Item No.	SRP/pc.
1	champagne bronze	Stainless Steel	146	96	133.53.318	\$18.99
2	champagne bronze	Stainless Steel	179	128	133.53.319	\$25.34
3	champagne bronze	Stainless Steel	211	160	133.53.320	\$28.56
4	champagne bronze	Stainless Steel	243	192	133.53.321	\$35.21
5	satin nickel	Stainless Steel	146	96	133.53.489	\$18.99
6	satin nickel	Stainless Steel	179	128	133.53.490	\$25.34
7	satin nickel	Stainless Steel	211	160	133.53.491	\$28.56
8	satin nickel	Stainless Steel	243	192	133.53.492	\$35.21

Note
Supplied with mounting screws.

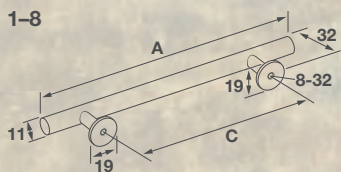

Dimensions in mm unless otherwise noted. Prices subject to change.



Radius **NEW**

BY AMEROCK

	Finish	Material	Item No.	SRP/pc.
1	matt black	Stainless Steel	133.53.382	\$42.29
2	champagne bronze	Stainless Steel	133.53.322	\$42.29
3	satin nickel	Stainless Steel	133.53.493	\$42.29
4	polished chrome	Stainless Steel	133.53.439	\$42.29
5	polished chrome	Stainless Steel	133.53.434	\$17.59
6	satin nickel	Stainless Steel	133.53.488	\$15.85
7	champagne bronze	Stainless Steel	133.53.317	\$15.85
8	matt black	Stainless Steel	133.53.377	\$15.85

Note
Supplied with mounting screws.

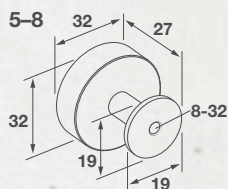
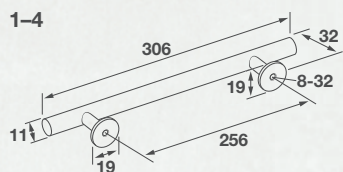



Radius NEW

BY AMEROCK

	Finish	Material	A	C	Item No.	SRP/pc.
1	polished chrome	Stainless Steel	146	96	133.53.435	\$21.11
2	polished chrome	Stainless Steel	179	128	133.53.436	\$28.18
3	polished chrome	Stainless Steel	211	160	133.53.437	\$31.73
4	polished chrome	Stainless Steel	243	192	133.53.438	\$35.21
5	matt black	Stainless Steel	146	96	133.53.378	\$18.99
6	matt black	Stainless Steel	179	128	133.53.379	\$25.34
7	matt black	Stainless Steel	211	160	133.53.380	\$25.94
8	matt black	Stainless Steel	243	192	133.53.381	\$35.21

Note
Supplied with mounting screws.

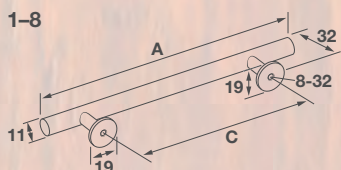

Dimensions in mm unless otherwise noted. Prices subject to change.



Destine NEW

BY AMEROCK

	Finish	Material	A	C	Item No.	SRP/pc.
1	champagne bronze	Zinc	-	-	133.53.312	\$15.85
2	champagne bronze	Zinc	125	96	133.53.313	\$18.99
3	champagne bronze	Zinc	157	128	133.53.314	\$25.34
4	champagne bronze	Zinc	189	160	133.53.315	\$28.56
5	champagne bronze	Zinc	252	224	133.53.316	\$35.21
6	matt black	Zinc	-	-	133.53.372	\$15.85
7	matt black	Zinc	125	96	133.53.373	\$18.99
8	matt black	Zinc	157	128	133.53.374	\$23.01
9	matt black	Zinc	189	160	133.53.375	\$28.56
10	matt black	Zinc	252	224	133.53.376	\$35.21

Note
Supplied with mounting screws.

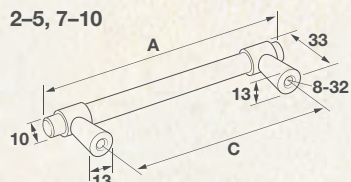
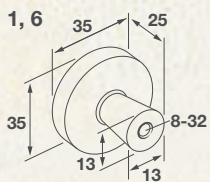

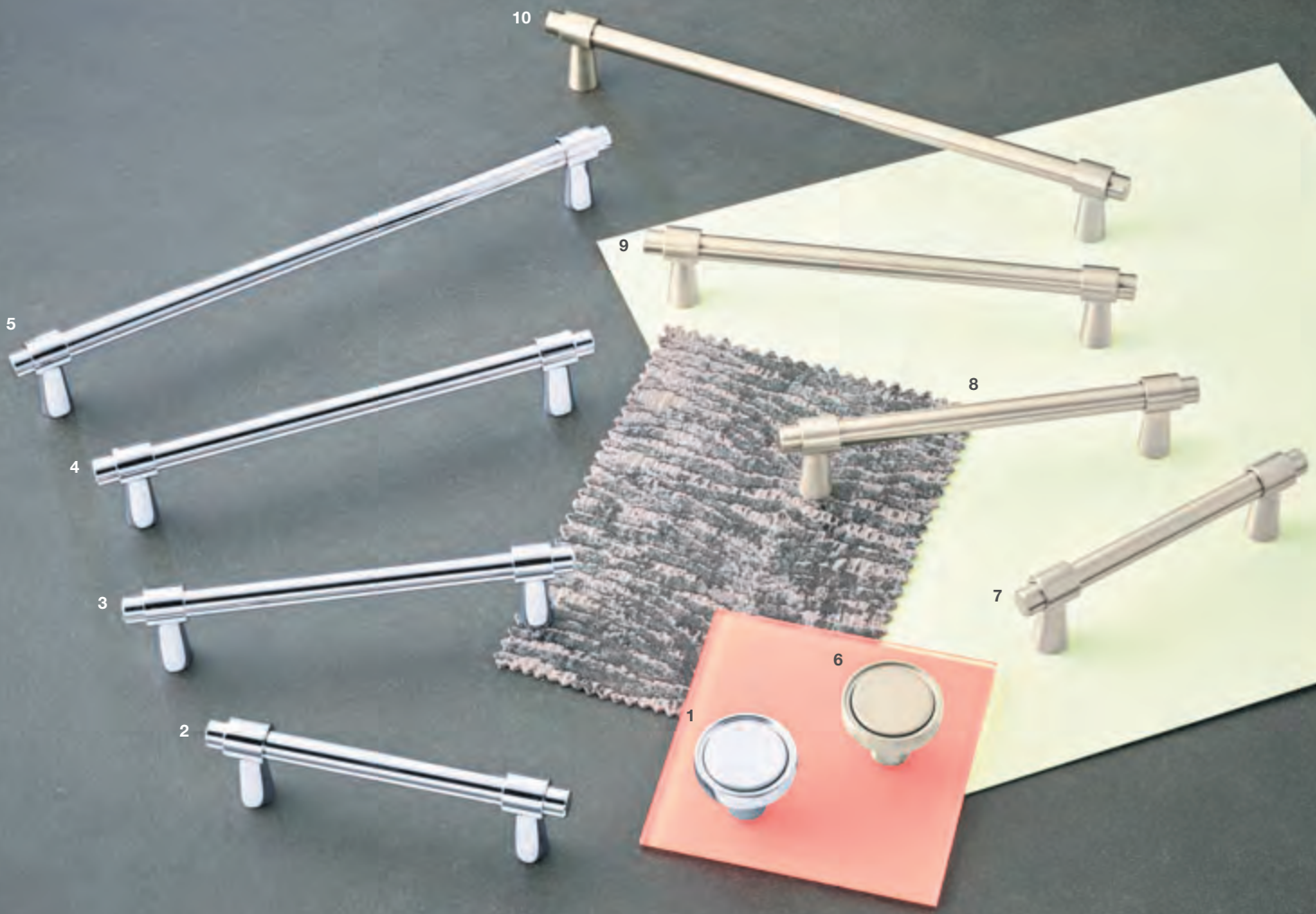

Destine NEW

BY AMEROCK

	Finish	Material	A	C	Item No.	SRP/pc.
1	polished chrome	Zinc	–	–	133.53.429	\$17.59
2	polished chrome	Zinc	125	96	133.53.430	\$21.11
3	polished chrome	Zinc	157	128	133.53.431	\$28.18
4	polished chrome	Zinc	189	160	133.53.432	\$31.73
5	polished chrome	Zinc	252	224	133.53.433	\$35.21
6	satin nickel	Zinc	–	–	133.53.483	\$15.85
7	satin nickel	Zinc	125	96	133.53.484	\$18.99
8	satin nickel	Zinc	157	128	133.53.485	\$25.34
9	satin nickel	Zinc	189	160	133.53.486	\$28.56
10	satin nickel	Zinc	252	224	133.53.487	\$35.21

Note
Supplied with mounting screws.

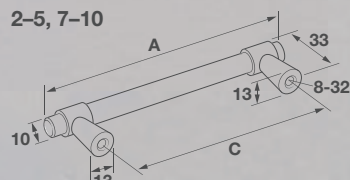
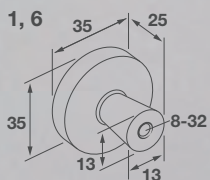

Dimensions in mm unless otherwise noted. Prices subject to change.



Mergence **NEW**

BY AMEROCK

	Finish	Material	A	C	Item No.	SRP/pc.
1	matt black/polished chrome	Zinc	125	96	133.53.466	\$24.67
2	matt black/polished chrome	Zinc	157	128	133.53.462	\$31.73
3	matt/black/polished chrome	Zinc	189	160	133.53.463	\$35.21
4	matt black/polished chrome	Zinc	252	224	133.53.464	\$38.73
5	matt black/polished chrome	Zinc	-	-	133.53.465	\$21.11
6	matt black/champagne bronze	Zinc	-	-	133.53.351	\$21.11
7	matt black/satin nickel	Zinc	-	-	133.53.409	\$21.11

Note
Supplied with mounting screws.

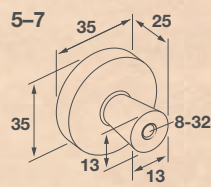
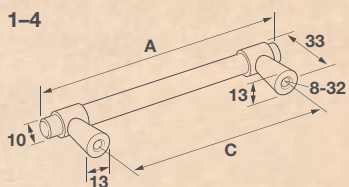

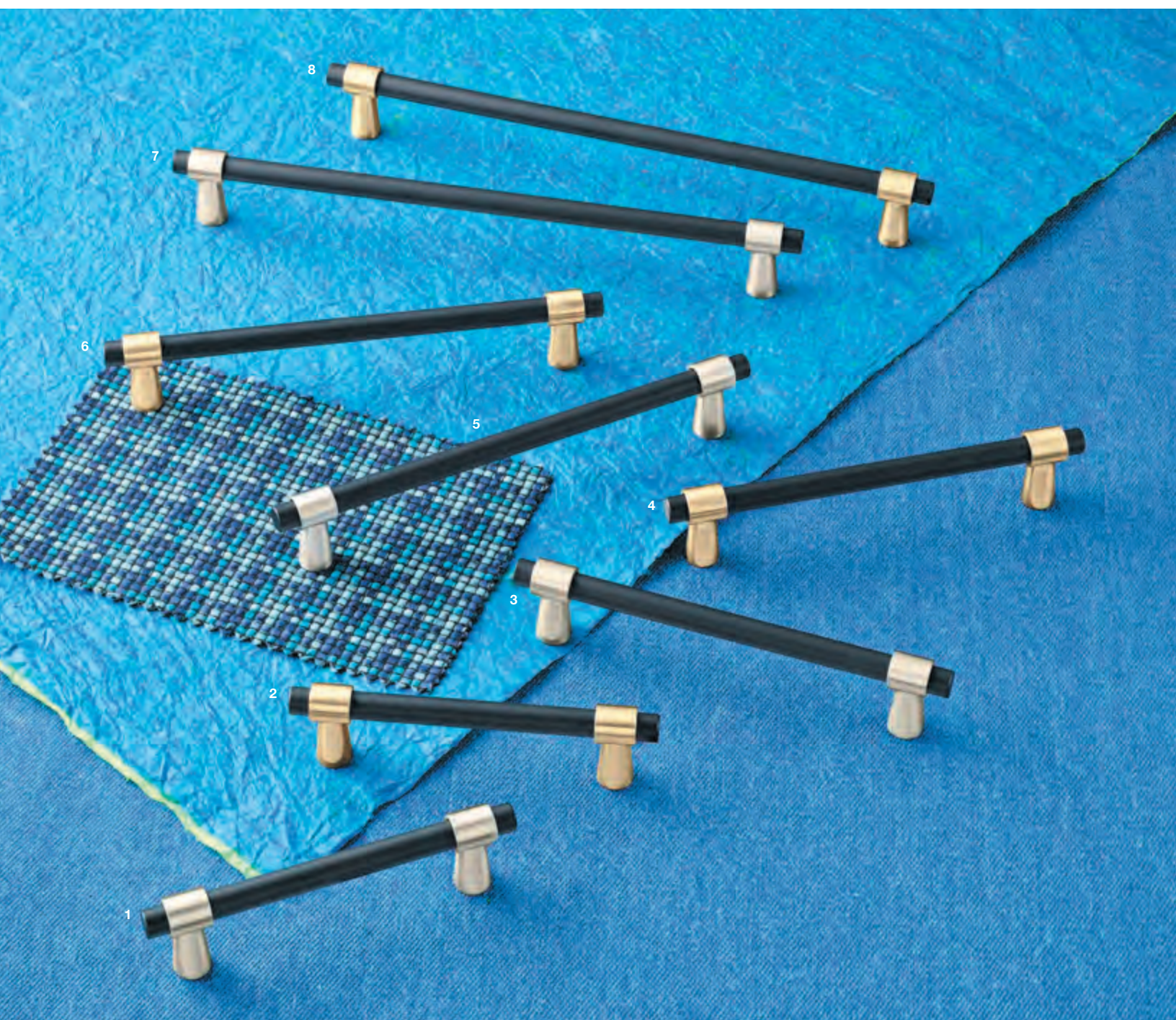

Mergence **NEW**

BY AMEROCK

	Finish	Material	A	C	Item No.	SRP/pc.
1	matt black/satin nickel	Zinc	125	96	133.53.352	\$24.67
2	matt black/champagne bronze	Zinc	125	96	133.53.347	\$24.67
3	matt/black/satin nickel	Zinc	157	128	133.53.353	\$31.73
4	matt black/champagne bronze	Zinc	157	128	133.53.348	\$31.73
5	matt black/satin nickel	Zinc	189	160	133.53.354	\$35.21
6	matt black/champagne bronze	Zinc	189	160	133.53.349	\$35.21
7	matt black/satin nickel	Zinc	252	224	133.53.410	\$38.78
8	matt black/champagne bronze	Zinc	252	224	133.53.350	\$38.78

Note
Supplied with mounting screws.

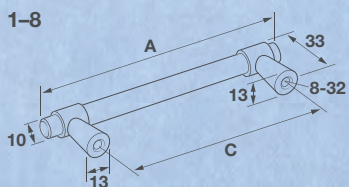

Dimensions in mm unless otherwise noted. Prices subject to change.



Premise NEW

BY AMEROCK

ADA 2-4, 6-8

	Finish	Material	A	C	Item No.	SRP/pc.
1	champagne bronze	Zinc	-	-	133.53.308	\$12.32
2	champagne bronze	Zinc	108	96	133.53.309	\$15.84
3	champagne bronze	Zinc	141	128	133.53.310	\$22.89
4	champagne bronze	Zinc	173	160	133.53.311	\$26.42
5	satin nickel	Zinc	-	-	133.53.479	\$12.32
6	satin nickel	Zinc	108	96	133.53.480	\$15.84
7	satin nickel	Zinc	141	128	133.53.481	\$22.89
8	satin nickel	Zinc	173	160	133.53.482	\$26.42

Note
Supplied with mounting screws.

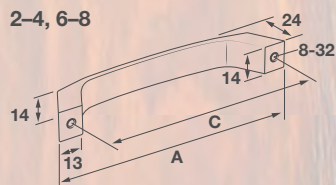
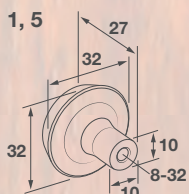



Premise NEW

BY AMEROCK

ADA 2-4, 6-8

	Finish	Material	A	C	Item No.	SRP/pc.
1	polished chrome	Zinc	-	-	133.53.425	\$12.32
2	polished chrome	Zinc	108	96	133.53.426	\$15.84
3	polished chrome	Zinc	141	128	133.53.427	\$22.89
4	polished chrome	Zinc	173	160	133.53.428	\$26.42
5	matt black	Zinc	-	-	133.53.368	\$12.32
6	matt black	Zinc	108	96	133.53.369	\$15.84
7	matt black	Zinc	141	128	133.53.370	\$22.89
8	matt black	Zinc	173	160	133.53.371	\$26.42

Note
Supplied with mounting screws.

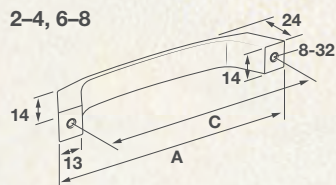
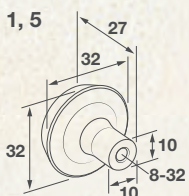

Dimensions in mm unless otherwise noted. Prices subject to change.

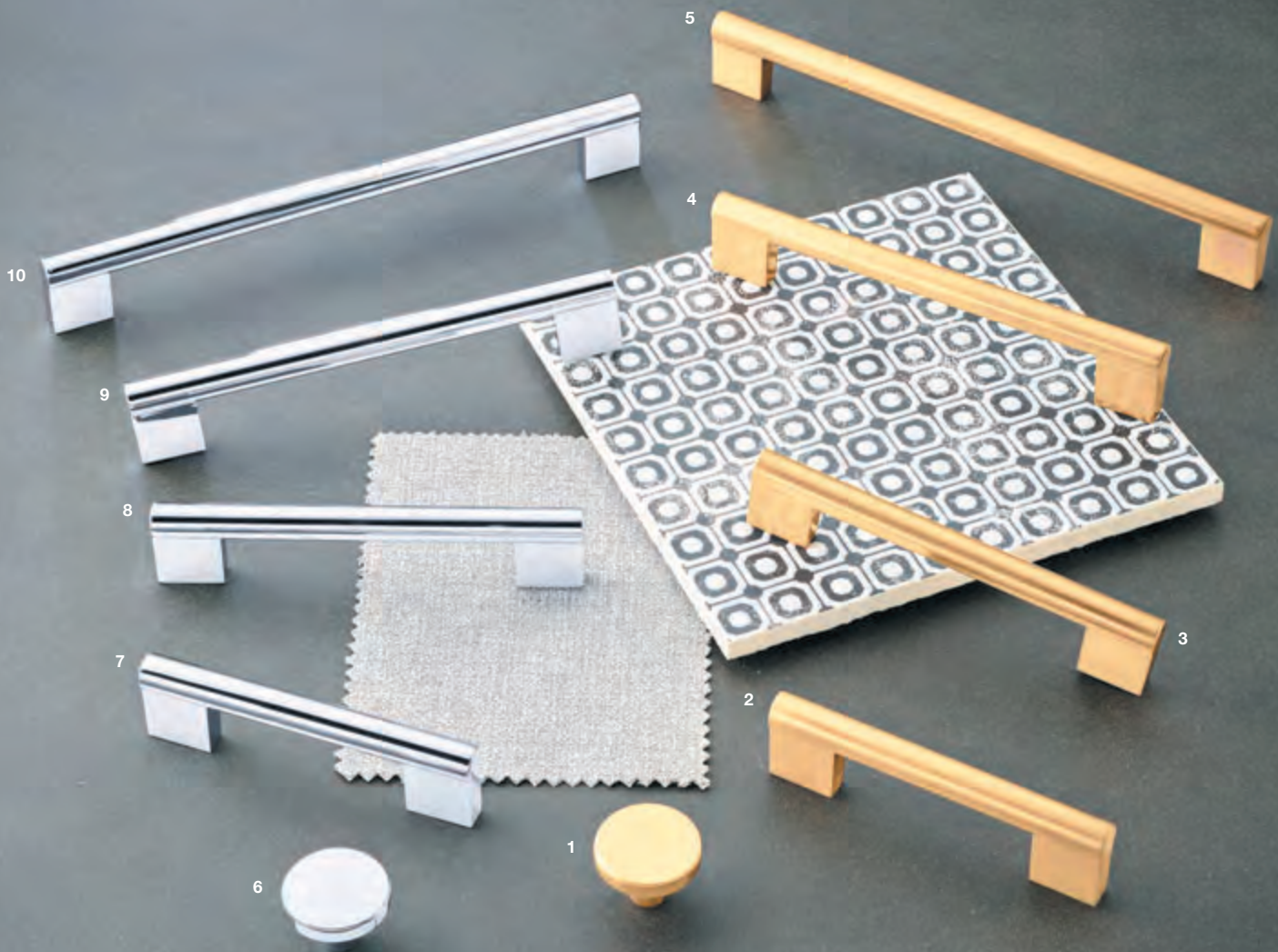

Versa NEW

BY AMEROCK

ADA 2-5, 7-10

	Finish	Material	A	C	Item No.	SRP/pc.
1	champagne bronze	Zinc	-	-	133.53.342	\$7.19
2	champagne bronze	Zinc	119	96	133.53.343	\$9.50
3	champagne bronze	Zinc	151	128	133.53.344	\$12.66
4	champagne bronze	Zinc	183	160	133.53.345	\$15.85
5	champagne bronze	Zinc	248	224	133.53.346	\$24.67
6	polished chrome	Zinc	-	-	133.53.457	\$8.80
7	polished chrome	Zinc	119	96	133.53.458	\$10.57
8	polished chrome	Zinc	151	128	133.53.459	\$14.06
9	polished chrome	Zinc	183	160	133.53.460	\$17.59
10	polished chrome	Zinc	248	224	133.53.461	\$24.67

Note
Supplied with mounting screws.

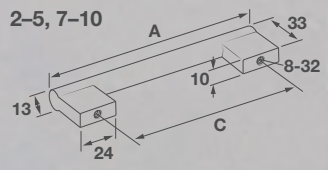
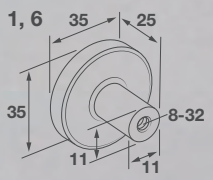



Versa NEW

BY AMEROCK

ADA 2-5, 7-10

	Finish	Material	A	C	Item No.	SRP/pc.
1	satin nickel	Zinc	-	-	133.53.515	\$7.92
2	satin nickel	Zinc	119	96	133.53.516	\$9.50
3	satin nickel	Zinc	151	128	133.53.517	\$12.66
4	satin nickel	Zinc	183	160	133.53.518	\$15.85
5	satin nickel	Zinc	248	224	133.53.519	\$24.67
6	matt black	Zinc	-	-	133.53.404	\$7.92
7	matt black	Zinc	119	96	133.53.405	\$9.50
8	matt black	Zinc	151	128	133.53.406	\$12.66
9	matt black	Zinc	183	160	133.53.407	\$15.85
10	matt black	Zinc	248	224	133.53.408	\$24.67

Note
Supplied with mounting screws.

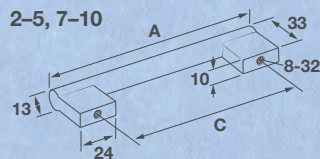
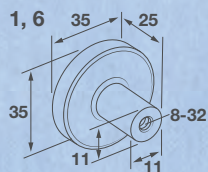

Dimensions in mm unless otherwise noted. Prices subject to change.

MINIMALIST

Oasis. Free from the distractions of clutter and busy ornament, minimalist design reveals a room's true character. Materials stress a natural simple state in wood, glass, stone, bamboo, woven grasses or wool. Deco should melt into the background, or is so candid and uncomplicated, it adds to the minimal statement. Integrated profiles that match the drawer and matt finishes complement the look.





Spartan



	Finish	Material	A	C	D	Item No.	SRP/pc.
1	silver colored	Zinc	90	64	83	155.01.931	\$5.51
2	polished chrome	Zinc	90	64	83	155.01.930	\$5.19
3	matt black	Zinc	90	64	83	155.01.932	\$4.58
4	matt black	Zinc	177	96	170	155.01.942	\$6.00
5	polished chrome	Zinc	177	96	170	155.01.940	\$6.72
6	silver colored	Zinc	177	96	170	155.01.941	\$7.03

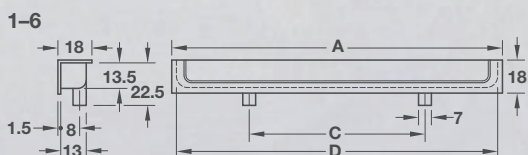



Impressions

	Finish	Material	Item No.	SRP/pc.
1	stainless steel look	Aluminum	151.85.030	\$95.68
2	stainless steel look	Zinc	151.85.089	\$14.94
3	matt aluminum	Aluminum	151.85.930	\$50.56
4	matt aluminum	Zinc	151.85.989	\$11.93
5	stainless steel look	Aluminum	151.86.030	\$117.12
6	stainless steel look	Zinc	151.86.089	\$14.94
7	matt aluminum	Aluminum	151.86.930	\$62.16
8	matt aluminum	Zinc	151.86.989	\$11.84

Note

Use 151.86.089 with 151.86.030; Use 151.85.089 with 151.85.030; Use 151.86.989 with 151.86.930; Use 151.85.989 with 151.85.930; Handles can be cut to size

1, 3

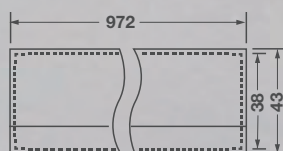

2, 4

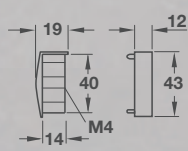

5, 7

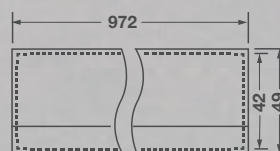

6, 8

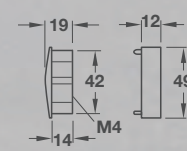

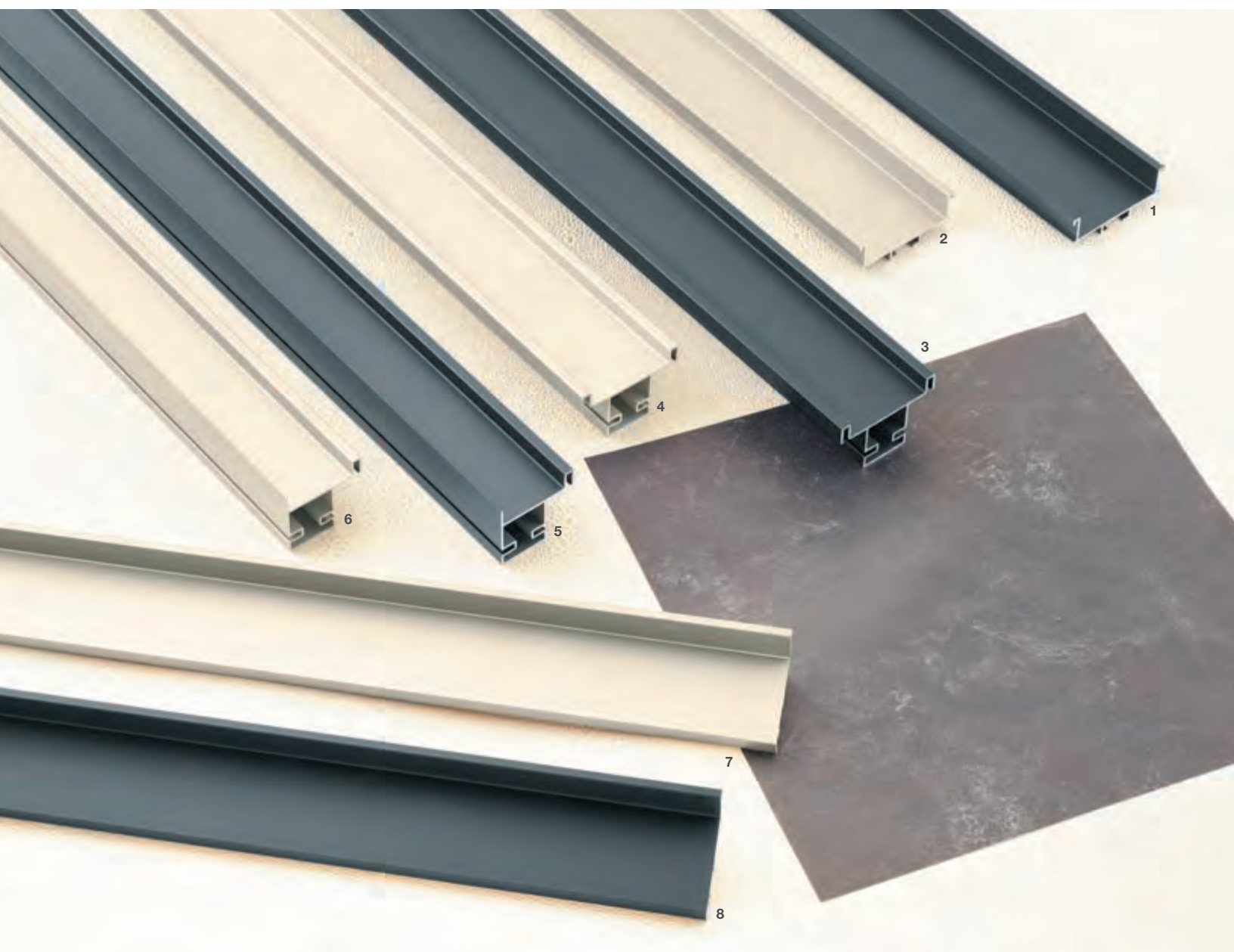

Venice

	Finish	Material	Item No.	SRP/pc.
1	black	Aluminum	126.63.003	\$133.12
2	matt nickel	Aluminum	126.63.001	\$133.12
3	black	Aluminum	126.63.011	\$196.44
4	matt nickel	Aluminum	126.63.009	\$178.58
5	black	Aluminum	126.63.015	\$171.14
6	matt nickel	Aluminum	126.63.013	\$171.14
7	matt nickel	Aluminum	126.63.005	\$107.78
8	black	Aluminum	126.63.007	\$107.78

Note

1-2, 7-8: Horizontal; 3-6: Vertical. Profile Length: 2895 mm

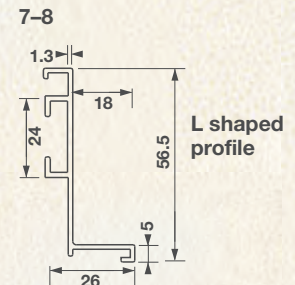
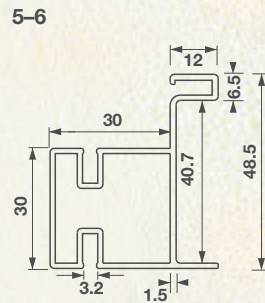
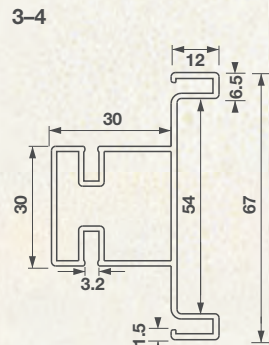
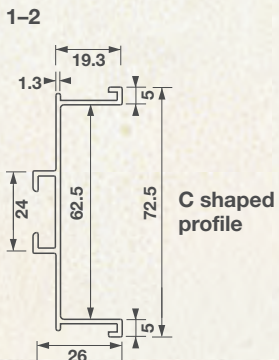

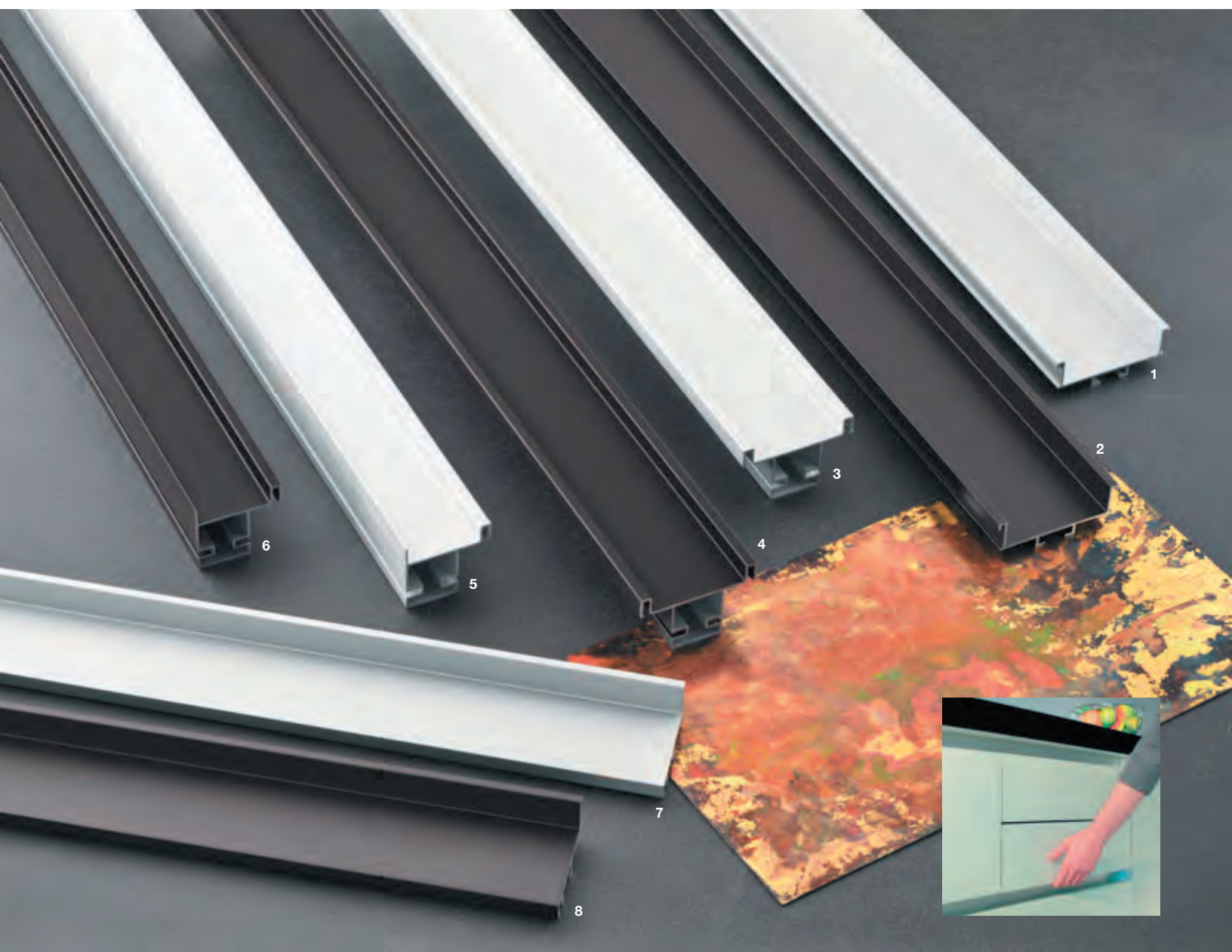

Venice

	Finish	Material	Item No.	SRP/pc.
1	matt aluminum	Aluminum	126.63.000	\$114.10
2	dark bronze	Aluminum	126.63.002	\$133.12
3	matt aluminum	Aluminum	126.63.008	\$171.14
4	dark bronze	Aluminum	126.63.010	\$196.44
5	matt aluminum	Aluminum	126.63.012	\$152.14
6	dark bronze	Aluminum	126.63.014	\$171.14
7	matt aluminum	Aluminum	126.63.004	\$95.10
8	dark bronze	Aluminum	126.63.006	\$107.78

Note

1-2, 7-8: Horizontal; 3-6: Vertical. Profile Length: 2895 mm

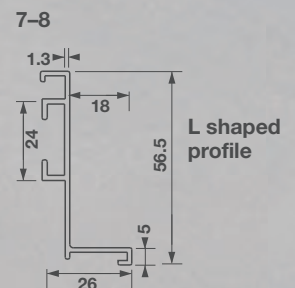
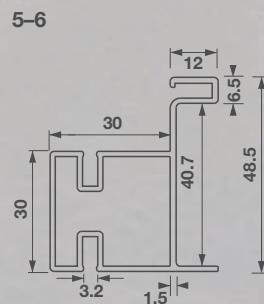
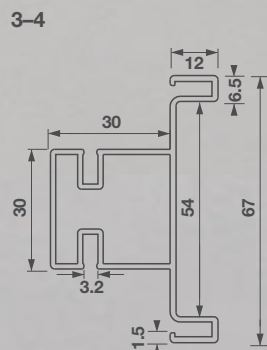
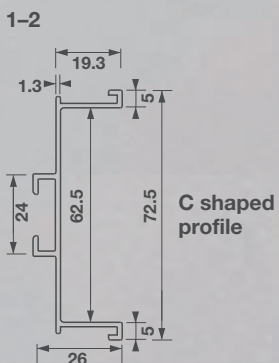



Venice Accessories

	3	4	5	6	SRP/pc.
Material	Plastic	Plastic	Plastic	Plastic	
Finish	Outer Corner	Outer Corner	Inner Corner	Inner Corner	
*matt aluminum	126.63.052	126.63.048	126.63.044	126.63.040	\$3.81
matt nickel	126.63.053	126.63.049	126.63.045	126.63.041	\$3.81
black	126.63.055	126.63.051	126.63.047	126.63.043	\$3.81
dark bronze	126.63.054	126.63.050	126.63.046	126.63.042	\$3.81

	7	8	9	11	12	13	SRP/pc.
Material	Plastic	Plastic	Plastic	Plastic	Plastic	Plastic	
Finish	L-cap, left	L-cap, right	C-cap, right or left	L-Cap, left	L-cap, right	C-cap, left or right	
*matt aluminum	126.63.024	126.63.028	126.63.032	126.63.016	126.63.020	126.63.036	\$2.54
matt nickel	126.63.025	126.63.029	126.63.033	126.63.017	126.63.021	126.63.037	\$2.54
black	126.63.027	126.63.031	126.63.035	126.63.019	126.63.023	126.63.039	\$2.54
dark bronze	126.63.026	126.63.030	126.63.034	126.63.018	126.63.022	126.63.038	\$2.54

Note
*Shown in matt aluminum. 3, 5, 7, 8, 11, 12 used with L shaped horizontal profiles and 4, 6, 9, 13 used with C shaped horizontal profiles on pages 163–164.

1. Straight Bracket

Finish	Material	Item No.	SRP/pc.
gray	Plastic	126.63.056	\$2.54

2. Connector, 90°

Finish	Material	Item No.	SRP/pc.
gray	Plastic	126.63.058	\$2.54

10. Bracket

Finish	Material	Item No.	SRP/pc.
gray	Plastic	126.63.057	\$2.54



Passages

	Finish	Material	Length	Working Length	Item No.	SRP/pc.
1	stainless steel look	Aluminum	2500	2460	126.53.003	\$58.40
2	matt aluminum	Aluminum	2500	2460	126.53.902	\$109.00
3	black RAL 9005	Aluminum	2500	2460	126.53.303	\$104.48
4	white RAL 9010	Aluminum	2500	2460	126.53.702	\$79.46

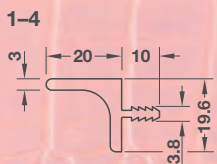

Dimensions in mm unless otherwise noted. Prices subject to change.

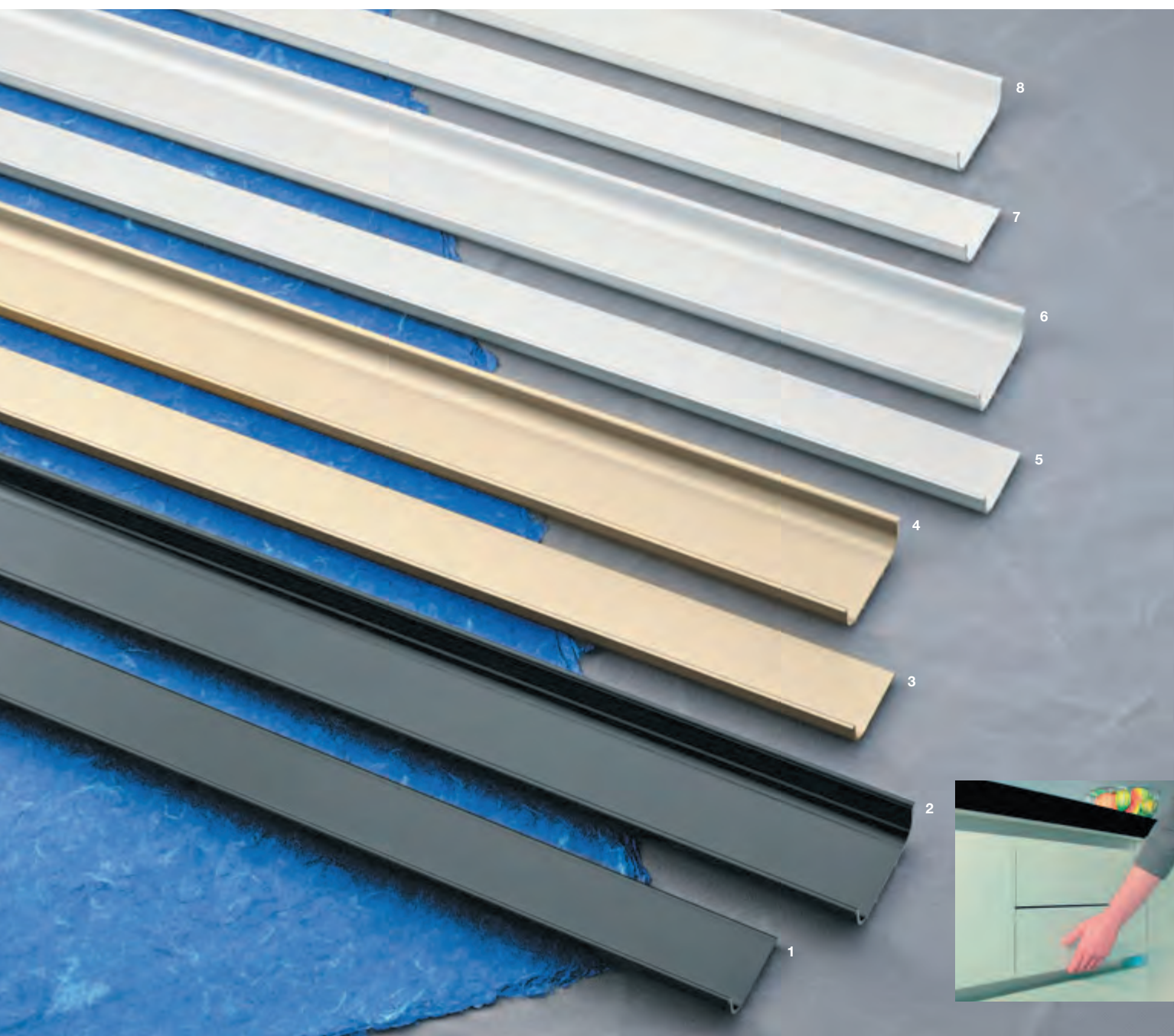

Passages

	Finish	Material	Length	Working Length	Item No.	SRP/pc.
1	black	Aluminum	2500	2460	126.37.300	\$126.06
2	black	Aluminum	2500	2460	126.36.300	\$160.52
3	stainless steel	Aluminum	2500	2460	126.37.001	\$62.20
4	stainless steel	Aluminum	2500	2460	126.36.001	\$85.82
5	matt	Aluminum	2500	2460	126.37.900	\$92.12
6	matt	Aluminum	2500	2460	126.36.900	\$125.36
7	white	Aluminum	2500	2460	126.37.700	\$82.40
8	white	Aluminum	2500	2460	126.36.700	\$117.66

Note
Refer to page 170 for required accessories.

1, 3, 5, 7

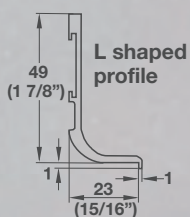

2, 4, 6, 8

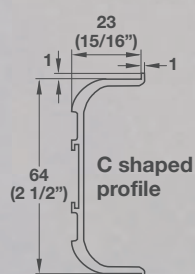

Installation

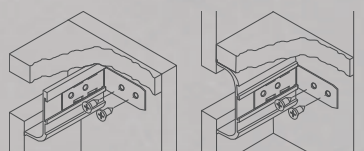

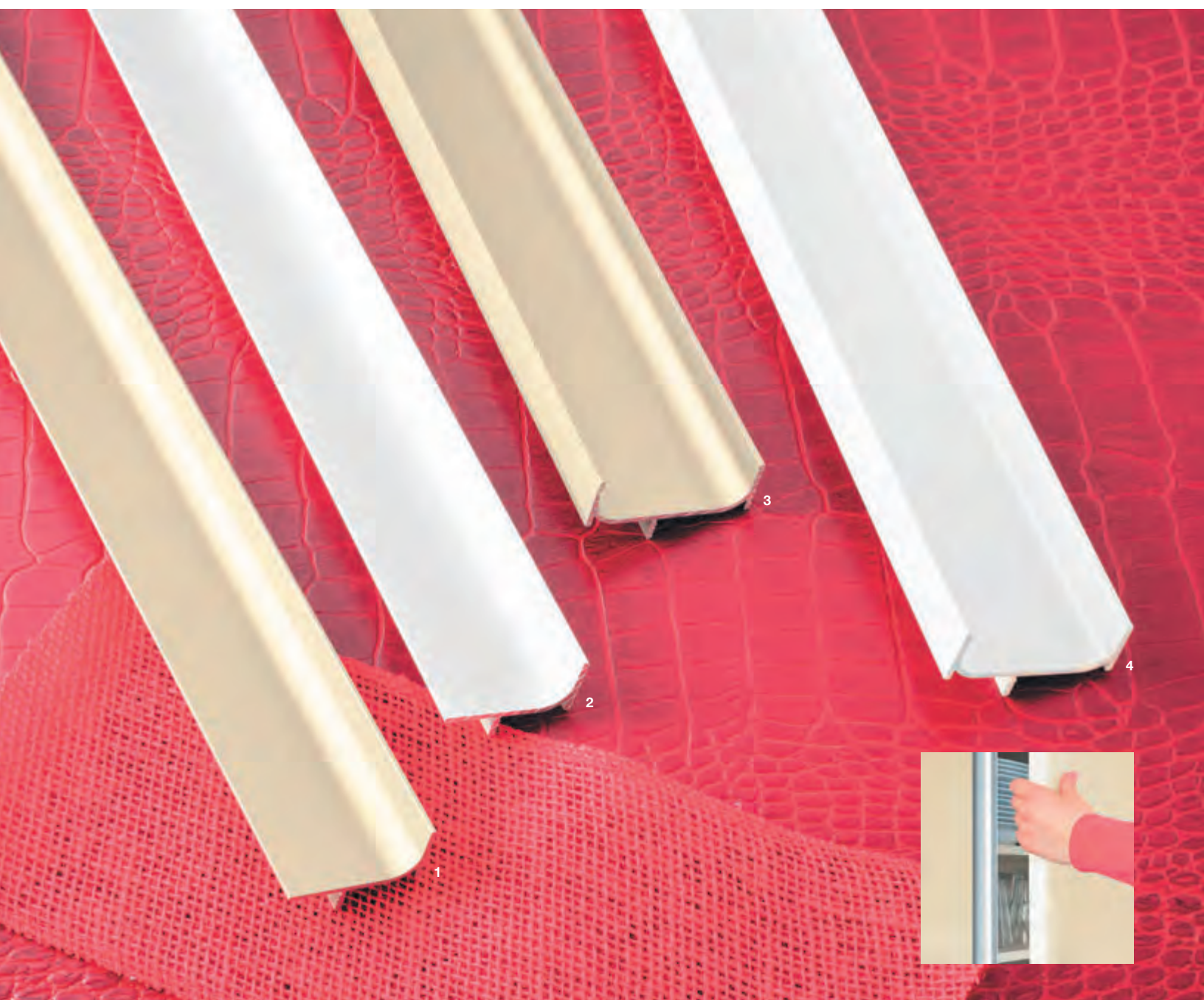

Passages

	Finish	Material	Length	Working Length	Item No.	SRP/pc.
1	stainless steel look	Aluminum	2500	2460	126.37.123	\$67.58
2	white RAL 9010	Aluminum	2500	2460	126.37.722	\$90.38
3	stainless steel look	Aluminum	2500	2460	126.37.113	\$95.34
4	white RAL 9010	Aluminum	2500	2460	126.37.712	\$127.92

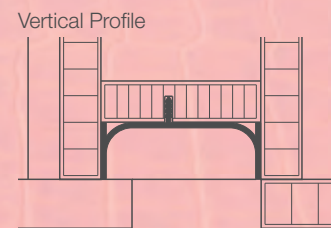
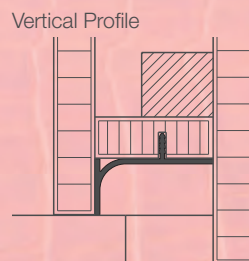
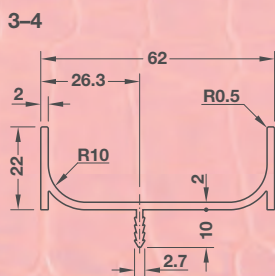
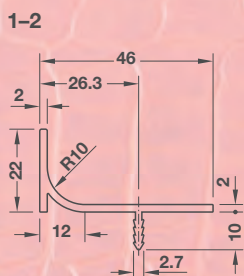

Dimensions in mm unless otherwise noted. Prices subject to change.



Passages

	Finish	Material	Length	Working Length	Item No.	SRP/pc.
1	matt aluminum	Aluminum	2500	2460	126.37.922	\$116.34
2	black RAL 9005	Aluminum	2500	2460	126.37.322	\$156.02
3	matt aluminum	Aluminum	2500	2460	126.37.912	\$178.40
4	black RAL 9005	Aluminum	2500	2460	126.37.312	\$223.94

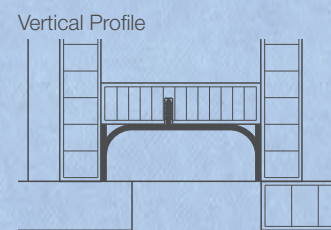
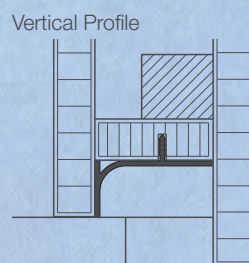
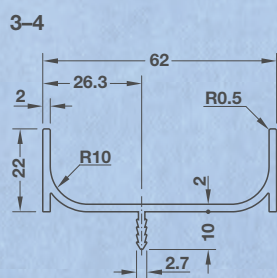
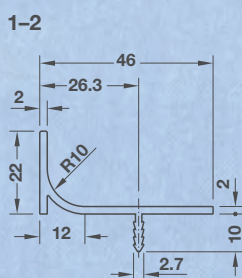



Passages Accessories

	1	2	SRP/pc.	3	4	SRP/pc.
Material	Plastic	Plastic		Plastic	Plastic	
Finish	Outside Corner	Inside Corner		Outside Corner	Inside Corner	
silver anodized*	126.37.986	126.37.981	\$3.44	126.37.985	126.37.980	\$6.04
stainless steel look	126.37.071	126.37.070	\$3.44	126.37.075	126.37.074	\$6.04
black	126.37.371	126.37.370	\$3.44	126.37.375	126.37.374	\$6.04
white	126.37.771	126.37.770	\$3.44	126.37.775	126.37.774	\$6.04

	5	SRP/pc.	6	SRP/pc.	7	SRP/pc.
Material	Plastic		Plastic		Plastic	
Finish	End Cap, right and left		End Cap, left		End Cap, right	
silver anodized*	126.37.996	\$2.40	126.37.998	\$2.40	126.37.997	\$2.40
stainless steel look	126.37.096	\$2.40	126.37.098	\$2.40	126.37.097	\$2.40
black	126.37.936	\$2.40	126.37.938	\$2.40	126.37.937	\$2.40
white	126.37.976	\$2.40	126.37.978	\$2.40	126.37.977	\$2.40

Note
*Shown in silver anodized. 1, 2, 5 used with C shaped profiles 2, 4, 6, 8 and 3, 4, 6, 7 used with L shaped profiles 1, 3, 5, 7 on page 167.



Mounting Bracket 90°

Material	Item No.	SRP/pc.
Stainless Steel	126.37.990	\$3.01

Dimensions in mm unless otherwise noted. Prices subject to change.

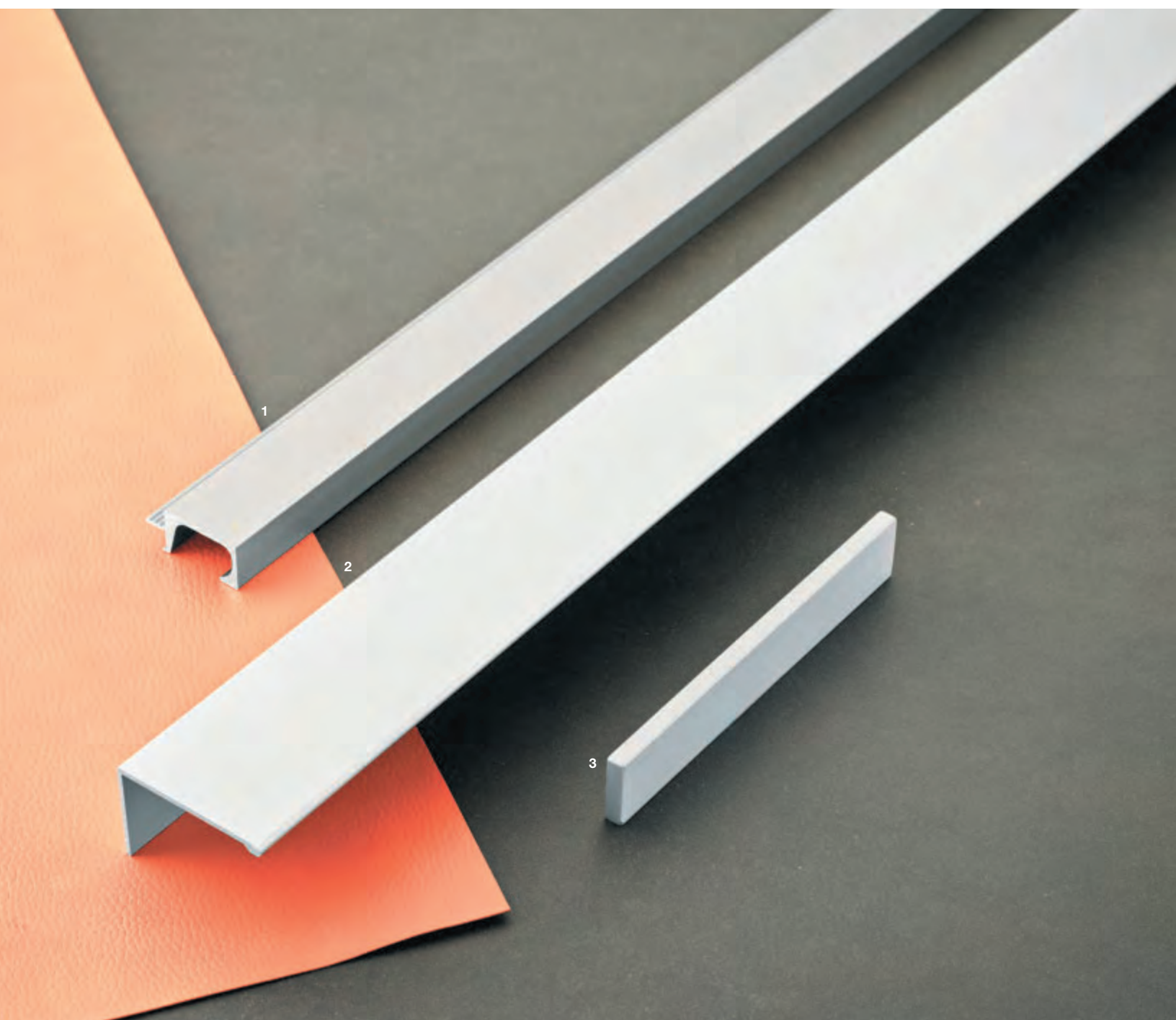

Minimalist NEW*

	Finish	Material	Length	Item No.	SRP/pc.
1*	stainless steel	Aluminum	2500	155.01.632	\$118.50
2	matt aluminum	Aluminum	3000	126.19.900	\$132.68
3	matt aluminum	Aluminum	–	106.11.904	\$18.45

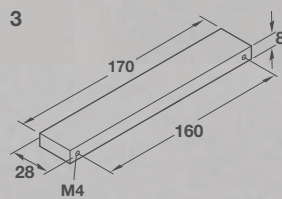
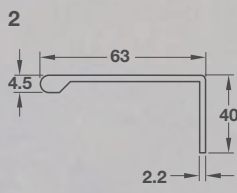
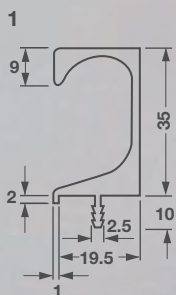



Minimalist

	Finish	Material	Length	Item No.	SRP/pc.
1	matt aluminum	Aluminum	2500	126.38.925	\$74.54
2	satin aluminum	Aluminum	2500	126.40.900	\$28.34
3	matt aluminum	Aluminum	2500	126.35.925	\$104.96

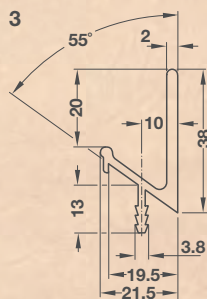
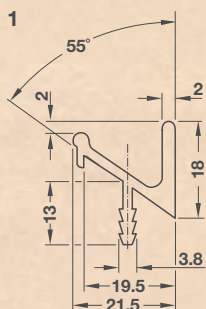

Dimensions in mm unless otherwise noted. Prices subject to change.

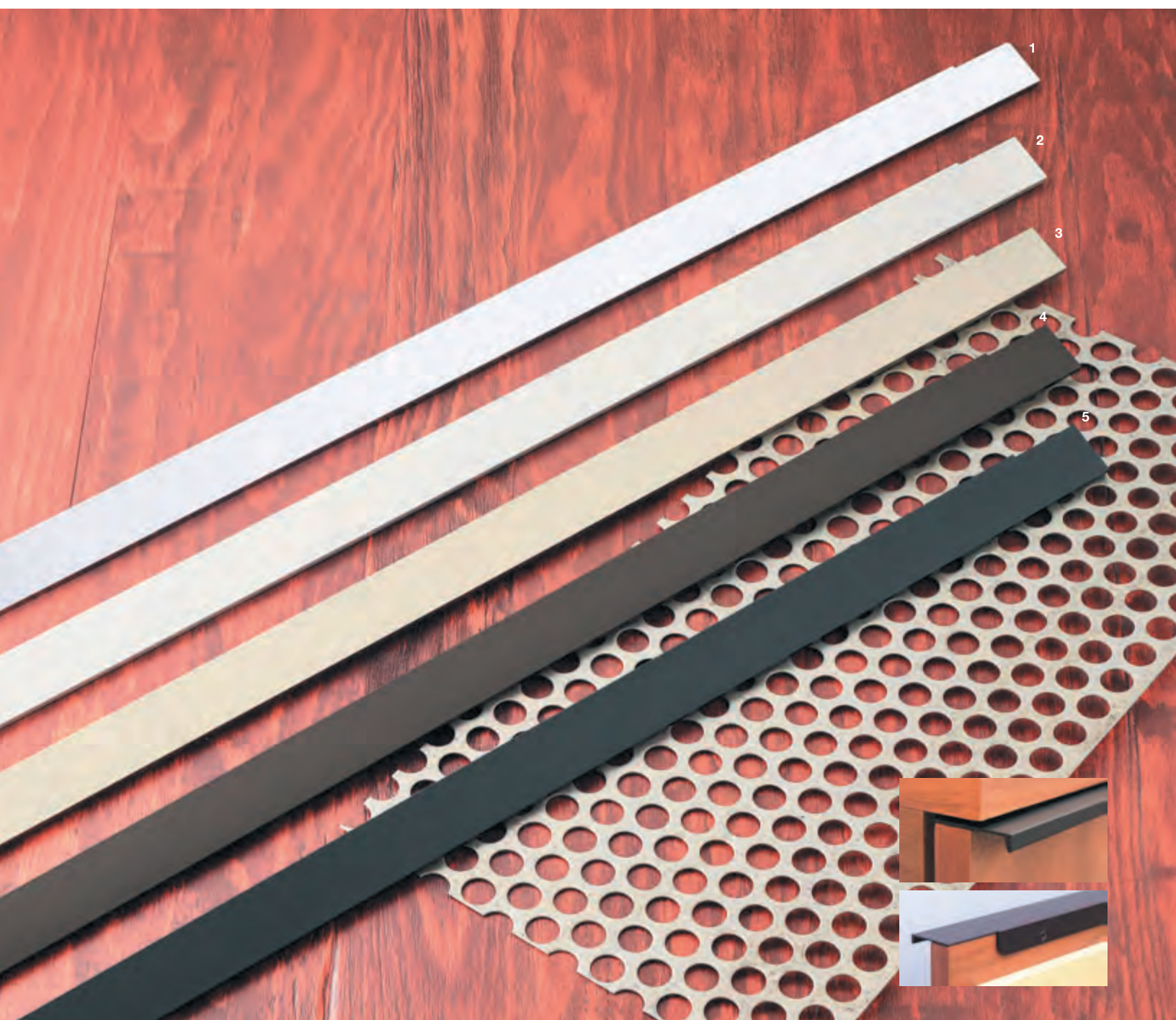

Oslo **NEW**

	Finish	Material	A	C	Item No.	SRP/pc.
1	polished chrome	Aluminum	910	768	106.04.134	\$66.67
2	aluminum anodized	Aluminum	910	768	106.04.130	\$61.75
3	matt nickel	Aluminum	910	768	106.04.131	\$64.22
4	dark bronze	Aluminum	910	768	106.04.132	\$64.22
5	matt black	Aluminum	910	768	106.04.133	\$64.22

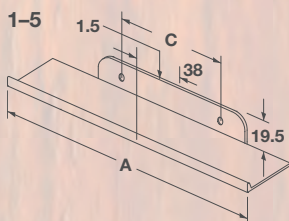



Oslo **NEW**

- | | Finish |
|---|-------------------|
| 1 | polished chrome |
| 2 | matt nickel |
| 3 | aluminum anodized |
| 4 | matt black |
| 5 | dark bronze |

	Material	A	C	Item No.	SRP/pc.
	Aluminum	757	576	106.04.124	\$54.34
	Aluminum	757	576	106.04.121	\$51.89
	Aluminum	757	576	106.04.120	\$49.39
	Aluminum	757	576	106.04.123	\$51.89
	Aluminum	757	576	106.04.122	\$51.89

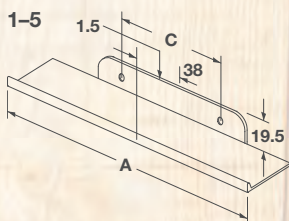

Dimensions in mm unless otherwise noted. Prices subject to change.



Oslo **NEW**

	Finish	Material	A	C	Item No.	SRP/pc.
1	dark bronze	Aluminum	605	448	106.04.112	\$46.92
2	aluminum anodized	Aluminum	605	448	106.04.110	\$44.47
3	matt nickel	Aluminum	605	448	106.04.111	\$46.92
4	polished chrome	Aluminum	605	448	106.04.114	\$49.39
5	matt black	Aluminum	605	448	106.04.113	\$46.92

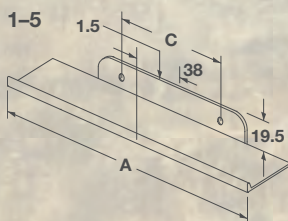

1



2



3



4



5



Oslo **NEW**

	Finish	Material	A	C	Item No.	SRP/pc.
1	polished chrome	Aluminum	529	384	106.04.104	\$39.53
2	dark bronze	Aluminum	529	384	106.04.102	\$37.06
3	matt nickel	Aluminum	529	384	106.04.101	\$37.06
4	aluminum anodized	Aluminum	529	384	106.04.100	\$35.83
5	matt black	Aluminum	529	384	106.04.103	\$37.06

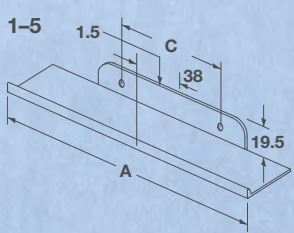

Dimensions in mm unless otherwise noted. Prices subject to change.



Oslo **NEW**

	Finish	Material	A	C	Item No.	SRP/pc.
1	polished chrome	Aluminum	452	320	106.04.094	\$33.36
2	aluminum anodized	Aluminum	452	320	106.04.090	\$30.89
3	matt nickel	Aluminum	452	320	106.04.091	\$32.14
4	dark bronze	Aluminum	452	320	106.04.092	\$32.14
5	matt black	Aluminum	452	320	106.04.093	\$32.14

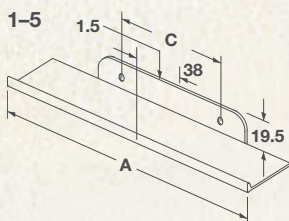



Oslo **NEW**

	Finish	Material	A	C	Item No.	SRP/pc.
1	polished chrome	Aluminum	376	256	106.04.084	\$25.97
2	matt nickel	Aluminum	376	256	106.04.081	\$24.72
3	aluminum anodized	Aluminum	376	256	106.04.080	\$23.45
4	dark bronze	Aluminum	376	256	106.04.082	\$24.72
5	matt black	Aluminum	376	256	106.04.083	\$24.72

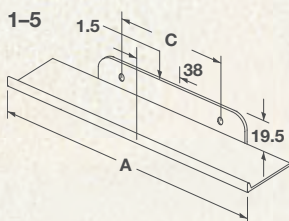

Dimensions in mm unless otherwise noted. Prices subject to change.



Oslo **NEW**

	Finish	Material	A	C	Item No.	SRP/pc.
1	polished chrome	Aluminum	224	96	106.04.064	\$16.05
2	aluminum anodized	Aluminum	224	96	106.04.060	\$13.58
3	matt nickel	Aluminum	224	96	106.04.061	\$14.81
4	dark bronze	Aluminum	224	96	106.04.062	\$14.81
5	matt black	Aluminum	224	96	106.04.063	\$14.81
6	polished chrome	Aluminum	300	160	106.04.074	\$20.99
7	aluminum anodized	Aluminum	300	160	106.04.070	\$18.52
8	matt nickel	Aluminum	300	160	106.04.071	\$19.75
9	dark bronze	Aluminum	300	160	106.04.072	\$19.75
10	matt black	Aluminum	300	160	106.04.073	\$19.75

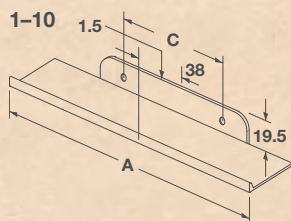



Providence **NEW**

	Finish	Material	A	C	Item No.	SRP/pc.
1	polished chrome	Aluminum	212	192	106.04.011	\$24.72
2	aluminum anodized	Aluminum	212	192	106.04.010	\$23.45
3	matt gold	Aluminum	212	192	106.04.012	\$25.97
4	matt black	Aluminum	212	192	106.04.013	\$24.72
5	polished chrome	Aluminum	84	64	106.04.001	\$13.58
6	aluminum anodized	Aluminum	84	64	106.04.000	\$12.35
7	matt gold	Aluminum	84	64	106.04.002	\$14.81
8	matt black	Aluminum	84	64	106.04.003	\$13.58

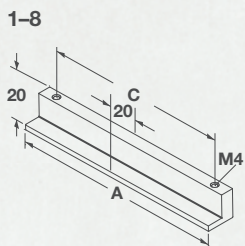

Dimensions in mm unless otherwise noted. Prices subject to change.

ARCHITECTURAL

Formidable. Structural vigor meets cutting-edge engineering. Then add clear sightlines to legends and trending influencers. Architectural deco styles can be commercial grade, often having special properties such as antimicrobial coatings or ADA-friendly knobs and pulls. Materials include corrosion resistant 304 grade stainless steel.







Architectural

 1-2, 4-5

	Finish	Material	A	B	Item No.	SRP/pc.
1	matt aluminum	Zinc	-	-	155.00.230	\$39.66
2	matt nickel	Zinc	-	-	155.00.240	\$45.38
3	polished nickel/matt chrome	Steel	-	-	153.20.715	\$5.23
4	brushed nickel	Zinc	39	35	155.00.010	\$3.81
5	brushed nickel	Zinc	50	45	155.00.011	\$4.64

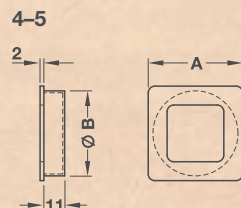
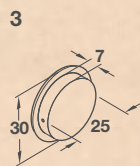
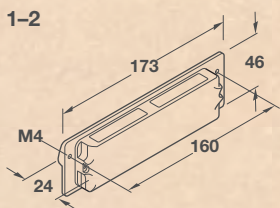



Atelier* and Architectural



	Finish	Material	Item No.	SRP/pc.
*1	brushed brass	Zinc	155.01.950	\$5.36
*2	brushed nickel	Zinc	155.01.951	\$5.36
*3	brushed nickel	Zinc	155.01.961	\$12.85
*4	brushed brass	Zinc	155.01.960	\$12.85
5	brushed brass	Zinc	155.01.794	\$8.89

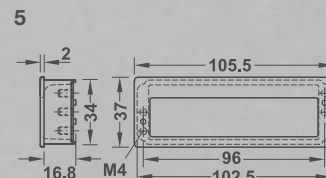
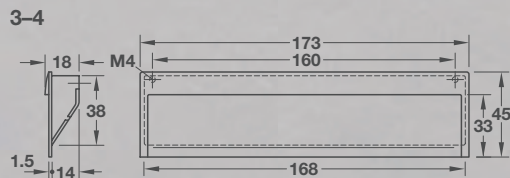
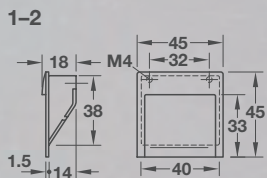



Architectural



	Finish	Material	Item No.	SRP/pc.
1	black	Plastic	129.57.603	\$4.68
2	white	Plastic	129.57.701	\$3.72
3	black	Plastic	158.23.300	\$2.06
4	natural	Beech	192.29.300	\$11.38
5	natural	Red Oak	192.48.456	\$4.53
6	matt, antimicrobial	Stainless Steel	110.52.435	\$29.96
7	polished nickel/matt chrome	Steel	152.00.727	\$6.90
8	polished chrome	Zinc	155.00.275	\$8.42
9	matt chrome	Zinc	155.00.270	\$7.50

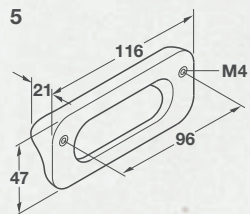
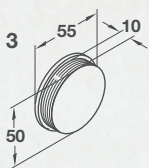
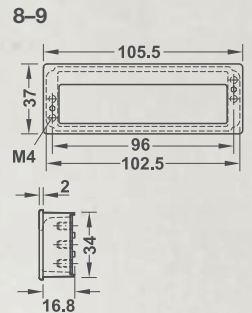
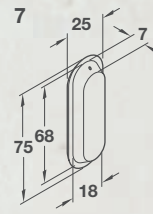
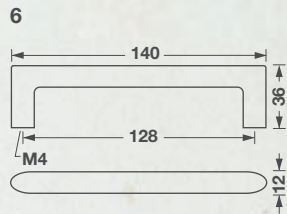
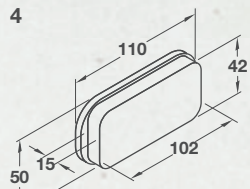
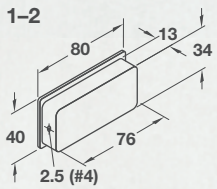



Architectural



	Finish	Material	A	C	Item No.	SRP/pc.
1	polished chrome	Zinc	174	160	110.22.202	\$32.26
2	polished chrome	Zinc	142	128	110.22.201	\$30.80
3	polished chrome	Zinc	-	-	106.59.210	\$28.97
4	matt chrome	Zinc	-	-	106.59.410	\$23.64

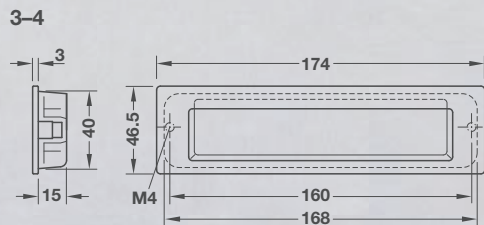
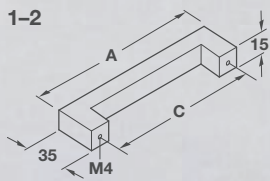

Dimensions in mm unless otherwise noted. Prices subject to change.



Architectural



Finish	Material	A	C	Item No.	SRP/pc.
1 matt	Stainless Steel	102	96	116.11.635	\$33.14
2 matt	Stainless Steel	134	128	116.11.644	\$38.62
3 matt	Stainless Steel	198	192	116.11.662	\$47.48
4 matt	Stainless Steel	262	256	116.11.671	\$58.98
5 satin nickel/black	Brass	-	-	151.12.606	\$136.50
6 matt chrome	Zinc	-	-	151.36.222	\$38.72
7 matt nickel, antimicrobial	Zinc	-	-	151.09.610	\$41.56
8 satin nickel	Zinc & Steel	-	-	151.67.001	\$62.48

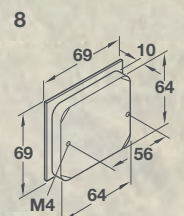
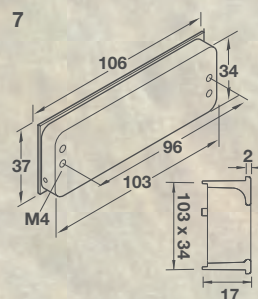
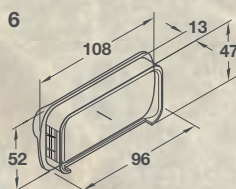
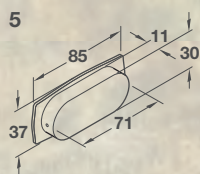
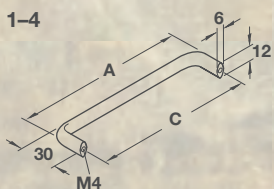



Architectural

	Finish
1	stainless steel look
2	matt
3	satin nickel
4	matt nickel

	Material
1	Zinc
2	Stainless Steel
3	Zinc, Steel
4	Brass

	Item No.	SRP/pc.
1	151.11.671	\$74.14
2	100.51.025	\$151.44
3	151.67.602	\$95.56
4	136.87.619	\$20.42

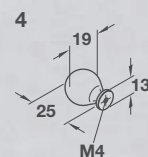
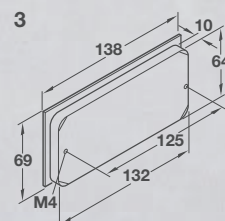
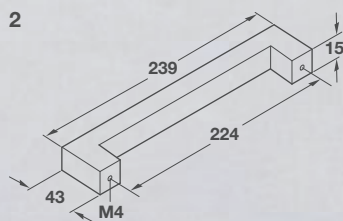
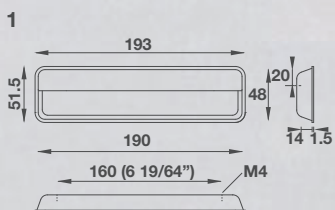



Architectural **NEW**

	Finish	Material	A	C	Item No.	SRP/pc.
1	matt	Stainless Steel 304	192	160	115.39.050	\$37.06
2	matt	Stainless Steel 304	224	192	115.39.051	\$38.14
3	matt	Stainless Steel 304	288	256	115.39.052	\$40.98
4	matt	Stainless Steel 304	352	320	115.39.053	\$42.62

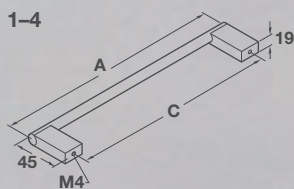



Architectural **NEW**

	Finish	Material	A	C	Item No.	SRP/pc.
1	matt	Stainless Steel 304	424	392	115.39.054	\$46.04
2	matt	Stainless Steel 304	524	492	115.39.055	\$47.12
3	matt	Stainless Steel 304	824	792	115.39.058	\$56.14

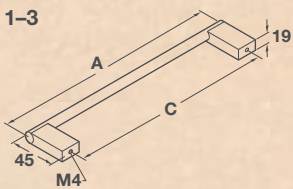

Dimensions in mm unless otherwise noted. Prices subject to change.



Uptown **NEW**

- Finish**
- 1 matt black
 - 2 stainless steel
 - 3 oil-rubbed bronze

- Material**
- Zinc
 - Zinc
 - Zinc

Item No.	SRP/pc.
902.00.702	\$23.53
902.00.710	\$30.46
902.00.705	\$23.92

Note
Refer to page 261 for matching appliance pulls.

1-3

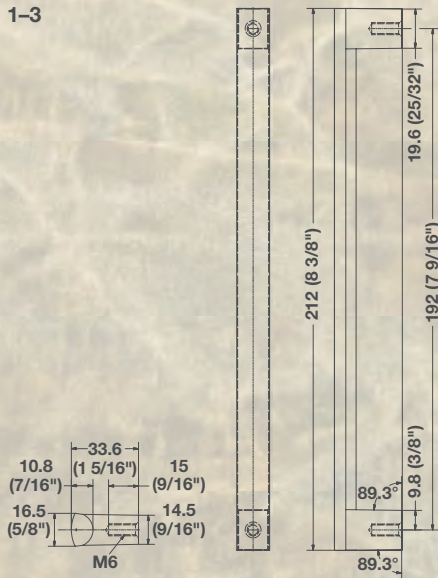

This page is left blank intentionally.

FARMHOUSE

Shiplap. Heirlooms.
Dinner bells.
Farmhouse style
highlights a tangle of
whites and weathered
woods, where
vintage or shabby
chic elements such
as a floral paper or a
fancy rug complement
bead board and
mullioned windows.
Deco features cup
pulls or knobs in warm
coppers, bronzes,
polished nickel and
even vintage-style glass.







Mulberry

BY HÄFELE

	Finish	Material	A	B	C	D	Item No.	SRP/pc.
1	polished nickel	Brass	136	25	128	16.5	155.02.153	\$48.36
2	polished nickel	Brass	170	26	160	17	155.02.163	\$50.72
3	polished nickel	Brass	77	20	64	34	151.40.203	\$26.98
4	polished nickel	Brass	115	23	96	42	151.40.204	\$50.60
5	polished nickel	Brass	204	25	192	42	151.40.207	\$67.30
6	brushed brass	Brass	202	33	192	42	155.02.190	\$70.50
7	brushed brass	Brass	77	20	64	35	151.40.633	\$28.10
8	brushed brass	Brass	115	23	96	42	151.40.634	\$53.12
9	polished nickel	Brass	34	-	32	32	123.02.700	\$22.80
10	polished nickel	Brass	37	-	38	38	123.02.710	\$29.64
11	brushed brass	Brass	34	-	32	32	155.02.252	\$22.80
12	brushed brass	Brass	37	-	38	38	123.02.670	\$30.40

Note

Refer to page 258 for matching appliance pulls.

1-2

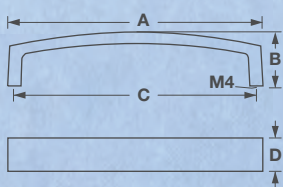

3-8

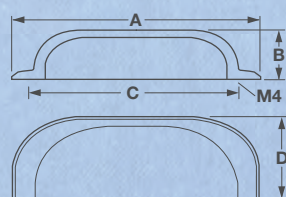

9-12

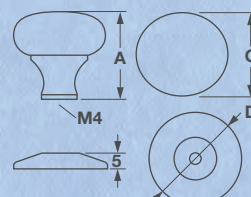



Mulberry

BY HÄFELE

	Finish	Material	A	B	C	D	Item No.	SRP/pc.
1	brushed nickel	Brass	136	25	128	17	155.02.150	\$28.92
2	brushed nickel	Brass	168	26	160	17	155.02.160	\$29.50
3	brushed nickel	Brass	77	20	64	34	151.40.603	\$24.78
4	brushed nickel	Brass	115	23	96	41	151.40.604	\$46.18
5	brushed nickel	Brass	204	25	192	42	151.40.607	\$74.06
6	brushed brass	Brass	136	25	128	16.5	116.35.665	\$50.36
7	brushed brass	Brass	168	26	160	17	155.02.162	\$52.84
8	brushed nickel	Brass	34	–	32	32	123.02.600	\$27.30
9	brushed nickel	Brass	40	–	38	38	155.02.260	\$36.47

Note

Refer to page 258 for matching appliance pulls.

1-2, 6-7

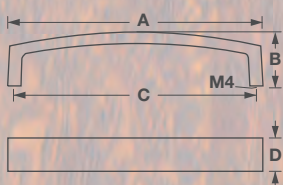

3-5

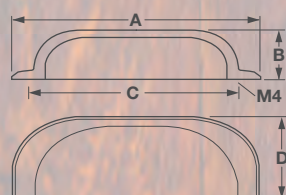

8-9

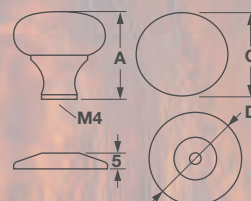



Farmhouse

BY HÄFELE - 4

	Finish	Material	Item No.	SRP/pc.
1	oil-rubbed bronze	Zinc	151.90.351	\$3.87
2	pewter	Zinc	151.90.951	\$4.04
3	natural	Maple	196.74.107	\$6.20
4	matt nickel	Zinc	103.05.620	\$28.74

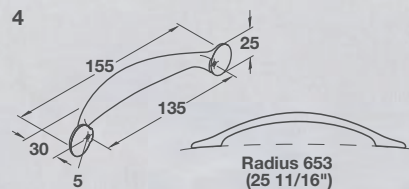
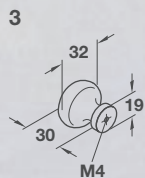
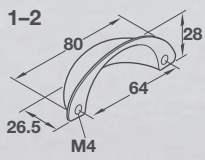



Farmhouse

BY HÄFELE - 6, 9

	Finish	Material	Item No.	SRP/pc.
1	matt nickel	Zinc	103.06.600	\$19.05
2	dark oil-rubbed bronze	Zinc	103.06.300	\$17.86
3	polished nickel	Zinc	103.06.700	\$18.00
4	polished nickel	Zinc	134.09.730	\$7.76
5	matt nickel	Zinc	134.09.633	\$7.54
6*	rustic copper	Zinc	134.09.001	\$11.04
7	dark oil-rubbed bronze	Zinc	134.09.330	\$8.23
8	dark oil-rubbed bronze	Zinc	105.61.300	\$19.39
9*	rustic copper	Zinc	105.61.014	\$16.18
10	matt nickel	Zinc	105.61.600	\$17.68

***Note**

Rustic copper finish is intended to look naturally worn with age and handling. The patina will vary from piece to piece.

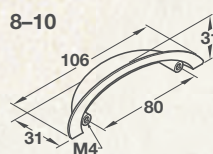
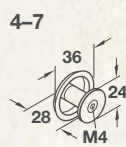
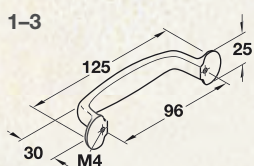



Dakota



	Finish	Material	Item No.	SRP/pc.
1	matt black	Zinc	155.01.984	\$3.55
2	antique pewter	Zinc	155.01.982	\$4.15
3	brushed nickel	Zinc	155.01.983	\$4.31
4	antique pewter	Zinc	155.01.971	\$4.69
5	brushed nickel	Zinc	155.01.973	\$5.30
6	matt black	Zinc	155.01.974	\$4.54

1-3

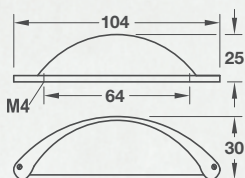

4-6

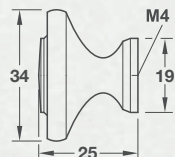



Beaulieu

	Finish	Material	A	B	C	Item No.	SRP/pc.
1	polished nickel	Brass	137	27	96	100.61.704	\$19.14
2	polished nickel	Brass	227	29	192	100.61.707	\$46.06
3	brushed nickel	Brass	137	27	96	100.61.625	\$15.83
4	brushed nickel	Brass	227	29	192	100.61.627	\$45.82
5	brushed nickel	Brass	35	30	–	123.02.631	\$28.72
6	brushed nickel	Brass	30	29	–	123.02.632	\$34.28
7	polished nickel	Brass	35	30	–	123.02.721	\$27.50
8	polished nickel	Brass	30	29	–	123.02.722	\$33.18

Note

Refer to page 258 for matching appliance pulls.

1-4

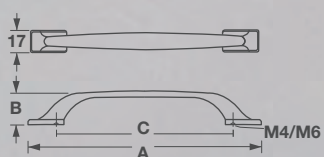

5-8

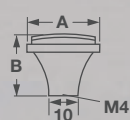



Beaulieu

	Finish	Material	A	B	C	Item No.	SRP/pc.
1	brushed brass	Brass	30	29	–	123.02.653	\$33.74
2	brushed brass	Brass	35	30	–	123.02.651	\$28.26
3	brushed brass	Brass	137	27	96	155.02.200	\$16.00
4	brushed brass	Brass	165	29	128	155.02.210	\$30.70
5	brushed brass	Brass	227	29	192	155.02.220	\$47.80
6	polished nickel	Brass	169	29	128	100.61.705	\$29.90
7	brushed nickel	Brass	169	29	128	100.61.626	\$30.48

Note
Refer to page 258 for matching appliance pulls.

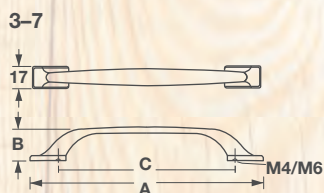
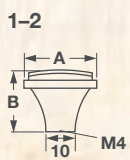



Highland Ridge

BY AMEROCK

ADA 5-9

	Finish	Material	A	B	C	D	Item No.	SRP/pc.
1	gold champagne	Zinc	-	-	-	-	133.53.152	\$17.76
2	gold champagne	Zinc	-	-	-	-	133.53.151	\$17.72
3	gold champagne	Zinc	-	-	-	-	133.53.155	\$22.86
4	gold champagne	Zinc	110	27	76 (3")	11	133.53.153	\$19.53
5	gold champagne	Zinc	132	29	96	14	133.53.154	\$21.28
6	gold champagne	Zinc	168	32	128	16	133.53.156	\$23.06
7	gold champagne	Zinc	217	33	160	17	133.53.157	\$27.60
8	polished nickel	Zinc	132	29	96	14	133.53.162	\$18.99
9	polished nickel	Zinc	168	32	128	16	133.53.022	\$19.07
10	polished nickel	Zinc	110	27	76 (3")	11	133.53.161	\$17.42

Note

Supplied with mounting screws. Refer to page 268 for matching appliance pulls.

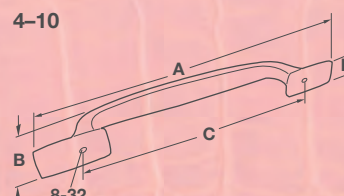
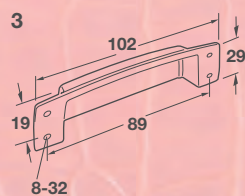
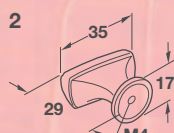
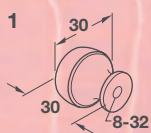



Highland Ridge

BY AMEROCK

ADA 4, 6-7

	Finish	Material	A	B	C	D	Item No.	SRP/pc.
1	black bronzed	Zinc	-	-	-	-	133.53.143	\$17.72
2	black bronzed	Zinc	-	-	-	-	133.53.144	\$16.94
3	black bronzed	Zinc	110	27	76 (3")	11	133.53.145	\$19.53
4	black bronzed	Zinc	132	29	96	14	133.53.146	\$21.28
5	black bronzed	Zinc	-	-	-	-	133.53.147	\$20.37
6	black bronzed	Zinc	168	32	128	16	133.53.148	\$23.06
7	black bronzed	Zinc	217	33	160	17	133.53.149	\$27.60

Note

Supplied with mounting screws. Refer to page 268 for matching appliance pulls.

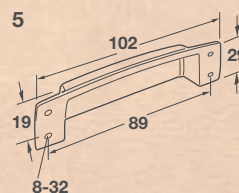
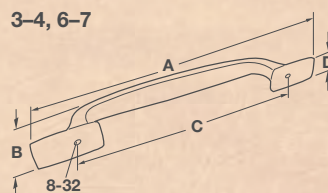
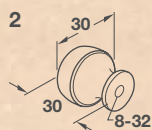
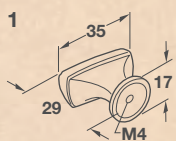



Highland Ridge

BY AMEROCK

ADA 6-9

	Finish	Material	A	B	C	D	Item No.	SRP/pc.
1	polished nickel	Zinc	-	-	-	-	133.53.159	\$15.84
2	polished nickel	Zinc	-	-	-	-	133.53.160	\$15.85
3	satin nickel	Zinc	-	-	-	-	133.53.167	\$17.72
4	satin nickel	Zinc	-	-	-	-	133.53.168	\$15.85
5	satin nickel	Zinc	110	27	76 (3")	11	133.53.169	\$19.53
6	satin nickel	Zinc	132	29	96	14	133.53.170	\$21.28
7	satin nickel	Zinc	168	32	128	16	133.53.172	\$23.06
8	satin nickel	Zinc	217	33	160	17	133.53.173	\$27.60
9	polished nickel	Zinc	217	33	160	17	133.53.165	\$24.67
10	polished nickel	Zinc	-	-	-	-	133.53.163	\$19.95
11	satin nickel	Zinc	-	-	-	-	133.53.171	\$22.86

Note

Supplied with mounting screws. Refer to page 268 for matching appliance pulls.

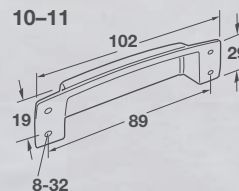
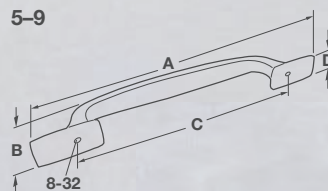
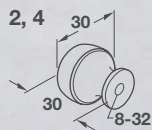
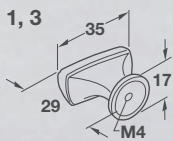



Ashby

BY AMEROCK

Finish	Material	Item No.	SRP/pc.
1 gold champagne	Zinc	133.50.135	\$23.76
2 gunmetal	Zinc	133.50.136	\$26.42
3 satin nickel	Zinc	133.50.153	\$23.35
4 oil-rubbed bronze	Zinc	133.50.137	\$23.35
5 weathered nickel	Zinc	133.50.139	\$19.46
6 polished nickel	Zinc	133.50.138	\$23.76

Note
Supplied with 1" mounting screws.

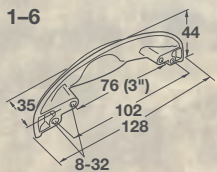



Cup Pulls

BY AMEROCK

Finish	Material	Item No.	SRP/pc.
1 oil-rubbed bronze	Zinc	133.50.150	\$7.62
2 polished nickel	Zinc	133.50.151	\$6.82
3 satin nickel	Zinc	133.50.152	\$6.82
4 gold champagne	Zinc	133.50.147	\$6.82
5 matt black	Zinc	133.50.149	\$6.82
6 polished chrome	Zinc	133.50.134	\$6.82
7 antique silver	Zinc	133.50.146	\$6.82

Note
Supplied with 1" mounting screws.

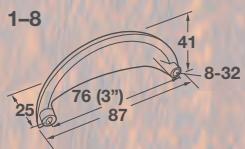

Dimensions in mm unless otherwise noted. Prices subject to change.

COASTAL

Breezy with a laid back beat. A palette of blues: ultra-marine, baby, turquoise combine with sandy whites, corals, and dune grass to evoke a relaxed vacation setting. Materials include linens, rope and sea glass. Deco styles include nautical themes, anchors, ropes, shell elements and geometric patterns with polished or brush brass finishes.







Coastal

BY HÄFELE - 4-5

	Finish	Material	A	C	Item No.	SRP/pc.
1	polished chrome	Zinc	172	160	107.96.233	\$12.77
2	polished chrome	Zinc	204	192	107.96.234	\$14.18
3	polished chrome	Zinc	332	320	107.96.238	\$24.76
4	white/polished chrome	Top/Base: Glass/Zinc	-	-	131.14.271	\$37.58
5	white/polished chrome	Top/Base: Glass/Zinc	-	-	109.50.274	\$54.62

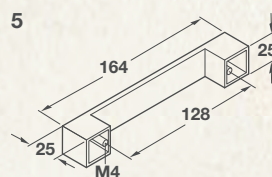
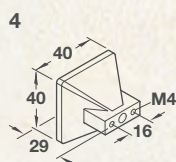
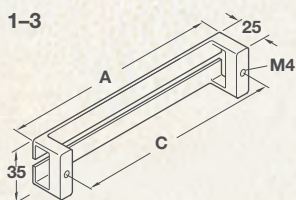



Coastal



	Finish	Material	A	B	C	D	Item No.	SRP/pc.
1	white	Zinc	136	10	128	27	116.22.745	\$12.93
2	white	Zinc	104	9	96	25	116.22.736	\$11.89
3	matt nickel	Zinc	-	-	-	-	104.09.600	\$5.20
4	matt chrome	Zinc	-	-	-	-	155.00.660	\$5.53
5	matt nickel	Zinc	-	-	-	-	104.96.652	\$26.26
6	matt nickel	Zinc	-	-	-	-	104.96.651	\$19.81
7	polished chrome	Zinc	-	-	-	-	104.96.252	\$26.72
8	polished chrome	Zinc	-	-	-	-	104.96.251	\$21.10
9	matt nickel	Zinc	-	-	-	-	136.81.610	\$15.97
10	polished chrome	Zinc	-	-	-	-	136.81.210	\$18.99

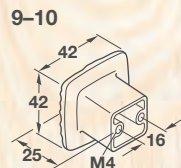
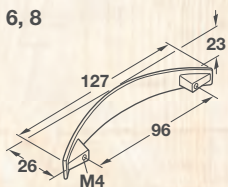
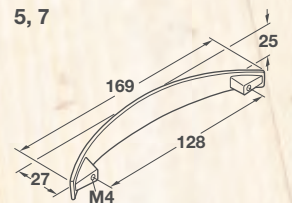
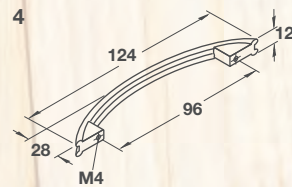
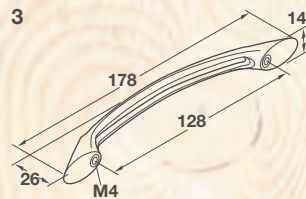
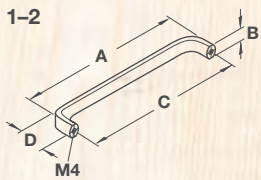

Dimensions in mm unless otherwise noted. Prices subject to change.



Sea Grass

BY AMEROCK

Finish	Material	A	C	Item No.	SRP/pc.
1 gold champagne	Zinc	127	96	133.50.375	\$18.99
2 gold champagne	Zinc	159	128	133.50.373	\$20.61
3 satin nickel	Zinc	127	96	133.50.381	\$21.11
4 satin nickel	Zinc	159	128	133.50.379	\$22.89
5 oil-rubbed bronze	Zinc	127	96	133.50.378	\$21.11
6 oil-rubbed bronze	Zinc	159	128	133.50.376	\$19.53
7 oil-rubbed bronze	Zinc	—	—	133.50.144	\$21.11
8 satin nickel	Zinc	—	—	133.50.145	\$21.11
9 gold champagne	Zinc	—	—	133.50.143	\$18.99

Note

Supplied with 1" mounting screws

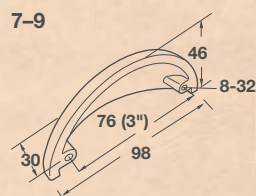
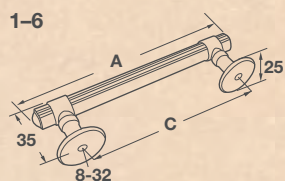



Sea Grass

BY AMEROCK

Finish	Material	A	B	C	Item No.	SRP/pc.
1 oil-rubbed bronze	Zinc	-	-	-	133.50.377	\$22.54
2 satin nickel	Zinc	-	-	-	133.50.380	\$26.42
3 gold champagne	Zinc	-	-	-	133.50.374	\$23.76
4 gold champagne	Zinc	44	30	33	133.50.634	\$17.42
5 gold champagne	Zinc	38	25	30	133.50.633	\$15.84
6 satin nickel	Zinc	44	30	33	133.50.638	\$19.37
7 satin nickel	Zinc	38	25	30	133.50.637	\$17.59
8 oil-rubbed bronze	Zinc	44	30	33	133.50.636	\$19.37
9 oil-rubbed bronze	Zinc	38	25	30	133.50.635	\$17.59

Note
Supplied with 1" mounting screws

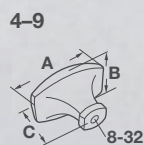
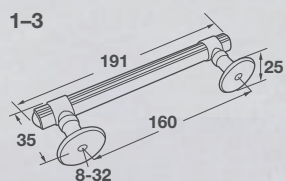

RUSTIC

Hideaway. Haven.
Off the grid. The rustic style channels the earth; wood, stone, bronze, copper, cast iron, and stone in their raw forms. Finishes enhance the rough textures; hammered, weathered and distressed patinas hone the organic beauty of imperfections.







Rustic

BY HÄFELE - 3-4

Finish

- 1 black oxide
- 2 black oxide
- 3 *rustic copper
- 4 *rustic copper
- 5 antique brass

Material

- Zinc 118.94.310 \$3.90
- Zinc 118.95.310 \$5.84
- Zinc 123.31.031 \$17.79
- Zinc 123.27.032 \$6.95
- Zinc 125.61.100 \$23.48

Note

*Rustic copper finish is intended to look naturally worn with age and handling. The patina will vary from piece to piece.

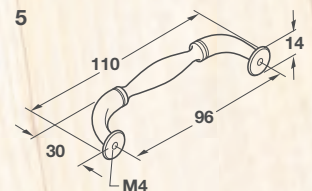
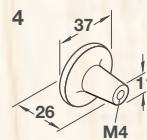
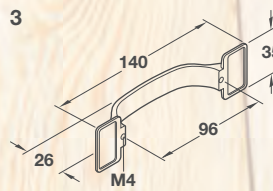
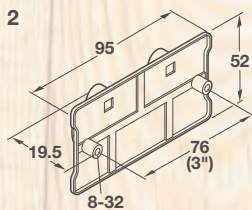
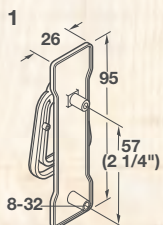



Rustic

Finish	Material	Item No.	SRP/pc.
1 antique black	Zinc	110.93.361	\$5.23
2 oil-rubbed bronze	Zinc	110.93.161	\$5.24
3 antique satin brass	Zinc	110.93.461	\$5.23
4 satin pewter	Zinc	110.93.961	\$5.23
5 satin nickel	Zinc	110.93.661	\$5.24
6 satin nickel	Zinc	110.93.662	\$3.86
7 satin pewter	Zinc	110.93.962	\$3.86
8 antique satin brass	Zinc	110.93.462	\$3.86
9 oil-rubbed bronze	Zinc	110.93.162	\$3.86
10 antique black	Zinc	110.93.362	\$3.86

Note
Supplied with 1" mounting screws.

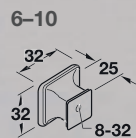
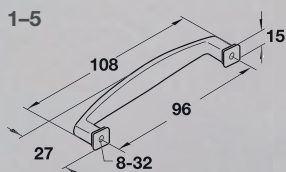



Arcadian

- | | Finish |
|---|----------------|
| 1 | old bronze |
| 2 | brushed bronze |
| 3 | natural |
| 4 | old bronze |
| 5 | brushed bronze |
| 6 | natural |

- | | Material |
|---|-----------------|
| 1 | Brass |
| 2 | Bronze |
| 3 | Britannium |
| 4 | Brass |
| 5 | Bronze |
| 6 | Britannium |

	Item No.	SRP/pc.
1	151.92.100	\$46.52
2	116.61.925	\$61.20
3	151.92.880	\$61.10
4	125.82.100	\$30.62
5	116.61.924	\$37.68
6	125.82.900	\$35.46

Note
Refer to page 259 for matching appliance pulls.

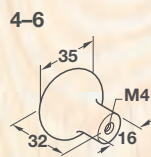
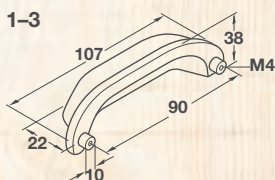



Arcadian

	Finish	Material	A	B	C	D	Item No.	SRP/pc.
1	old bronze	Brass	103	30	78	20	116.61.100	\$35.04
2	natural	Britannium	103	30	78	20	116.61.000	\$39.88
3	brushed bronze	Bronze	103	30	78	20	116.61.920	\$41.36
4	old bronze	Brass	154	35	128	22	116.61.102	\$45.40
5	natural	Britannium	154	35	128	22	116.61.002	\$48.18
6	brushed bronze	Bronze	154	35	128	22	116.61.921	\$57.22

Note

Refer to page 259 for matching appliance pulls.

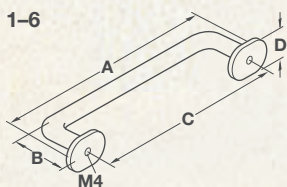

Dimensions in mm unless otherwise noted. Prices subject to change.



Blackrock

BY AMEROCK

ADA 4

	Finish	Material	A	B	C	D	Item No.	SRP/pc.
1	black bronzed	Zinc	30	27	-	30	133.50.221	\$11.08
2	black bronzed	Zinc	38	33	-	38	133.50.222	\$15.80
3	black bronzed	Zinc	95	27	76 (3")	14	133.50.163	\$11.25
4	black bronzed	Zinc	117	30	96	14	133.50.164	\$12.66
5	polished nickel	Zinc	30	27	-	30	133.53.068	\$11.08
6	polished nickel	Zinc	38	33	-	38	133.53.070	\$17.59
7	gold champagne	Zinc	38	33	-	38	133.53.060	\$17.59
8	gold champagne	Zinc	30	27	-	30	133.53.058	\$11.08

Note
Supplied with 1" mounting screws. Refer to page 264 for matching appliance pulls.

1-2, 5-8

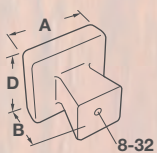

3-4

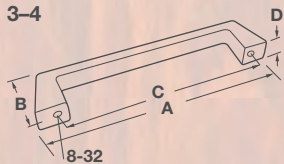

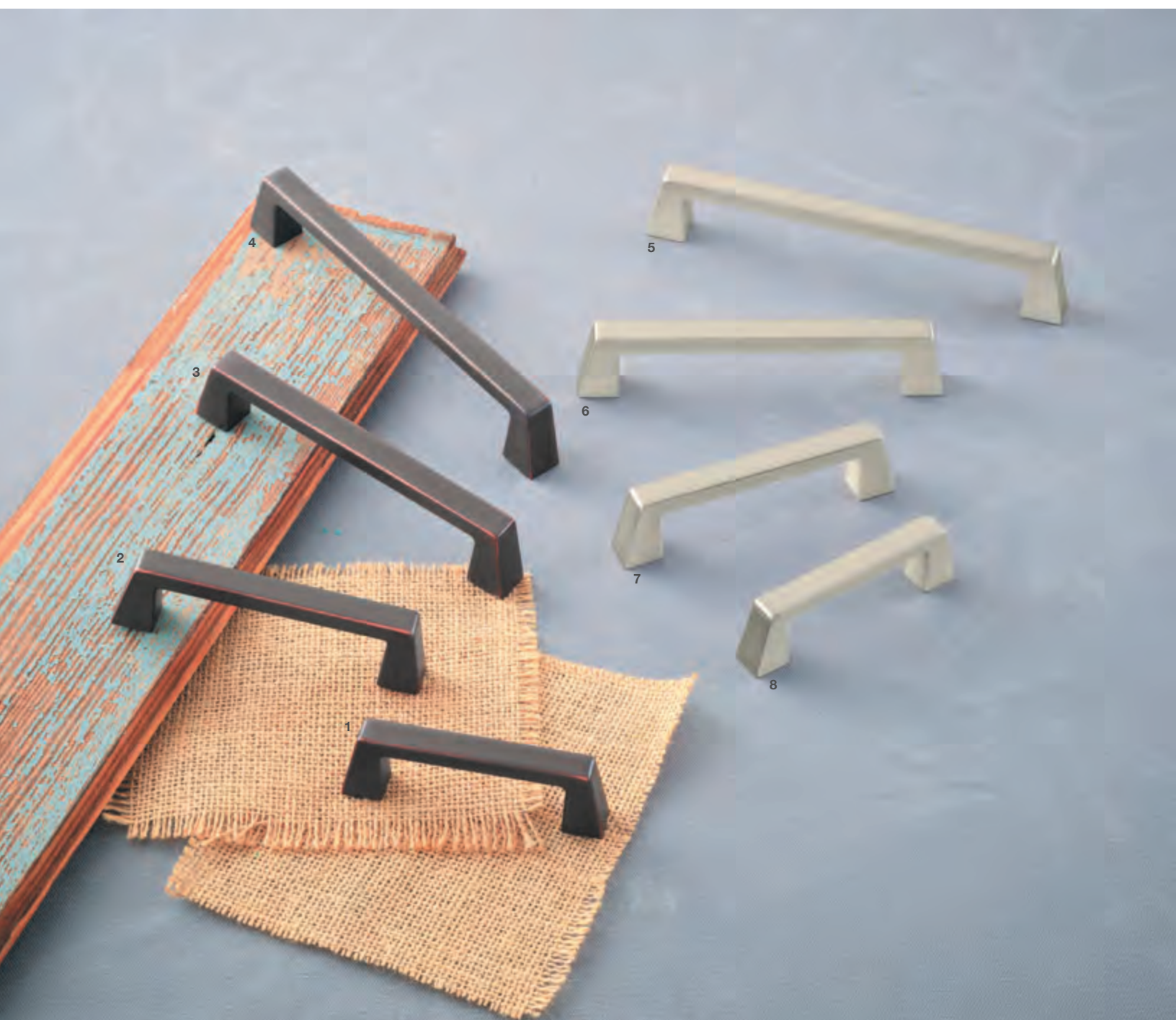

Blackrock

BY AMEROCK

ADA 2-4, 6-7

	Finish	Material	A	B	C	D	Item No.	SRP/pc.
1	oil-rubbed bronze	Zinc	95	27	76 (3")	14	133.50.167	\$11.08
2	oil-rubbed bronze	Zinc	117	30	96	14	133.50.168	\$12.66
3	oil-rubbed bronze	Zinc	151	30	128	16	133.50.165	\$14.23
4	oil-rubbed bronze	Zinc	184	32	160	16	133.50.166	\$15.84
5	satin nickel	Zinc	184	32	160	16	133.50.170	\$15.98
6	satin nickel	Zinc	151	30	128	16	133.50.169	\$14.23
7	satin nickel	Zinc	117	30	96	14	133.50.172	\$12.66
8	satin nickel	Zinc	95	27	76 (3")	14	133.50.171	\$11.25

Note

Supplied with 1" mounting screws. Refer to page 264 for matching appliance pulls.

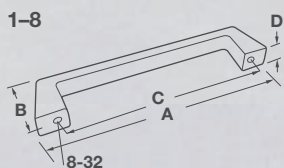



Blackrock

BY AMEROCK

ADA 1-3

	Finish	Material	A	B	C	D	Item No.	SRP/pc.
1	black bronzed	Zinc	151	30	128	16	133.50.161	\$14.23
2	black bronzed	Zinc	184	32	160	16	133.50.162	\$15.98
3	polished nickel	Zinc	184	32	160	16	133.53.075	\$17.59
4	polished nickel	Zinc	95	27	76 (3")	14	133.53.072	\$11.08
5	polished nickel	Zinc	-	-	-	-	133.53.071	\$12.32

Note

Supplied with 1" mounting screws. Refer to page 264 for matching appliance pulls.

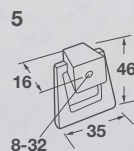
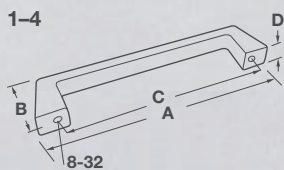



Blackrock

BY AMEROCK

ADA 5-7

	Finish	Material	A	B	C	D	Item No.	SRP/pc.
1	gold champagne	Zinc	33	27	-	-	133.53.057	\$9.50
2	gold champagne	Zinc	44	33	-	-	133.53.059	\$15.84
3	polished nickel	Zinc	44	33	-	-	133.53.069	\$15.84
4	polished nickel	Zinc	33	27	-	-	133.53.067	\$9.50
5	polished nickel	Zinc	117	30	96	14	133.53.073	\$12.66
6	polished nickel	Zinc	151	30	128	16	133.53.074	\$14.23
7	gold champagne	Zinc	117	30	96	14	133.53.063	\$12.66

Note

Supplied with 1" mounting screws. Refer to page 264 for matching appliance pulls.

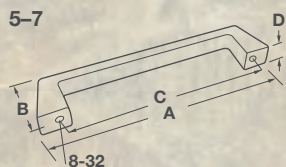
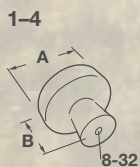



Blackrock

BY AMEROCK

	Finish	Material	A	B	D	Item No.	SRP/pc.
1	oil-rubbed bronze	Zinc	30	27	30	133.50.225	\$11.08
2	oil-rubbed bronze	Zinc	33	27	—	133.50.227	\$9.50
3	oil-rubbed bronze	Zinc	38	33	38	133.50.226	\$15.84
4	oil-rubbed bronze	Zinc	44	33	—	133.50.228	\$15.84
5	oil-rubbed bronze	Zinc	—	—	—	133.50.653	\$10.52
6	satin nickel	Zinc	—	—	—	133.50.654	\$9.40
7	satin nickel	Zinc	38	33	38	133.50.230	\$15.80
8	satin nickel	Zinc	44	33	—	133.50.232	\$14.25
9	satin nickel	Zinc	30	27	30	133.50.229	\$11.08
10	satin nickel	Zinc	33	27	—	133.50.231	\$9.50

Note
Supplied with 1" mounting screws. Refer to page 264 for matching appliance pulls.

1, 3, 7, 9

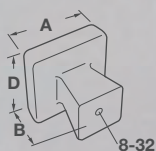

2, 4, 8, 10

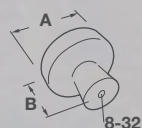

5-6

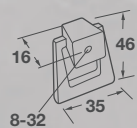

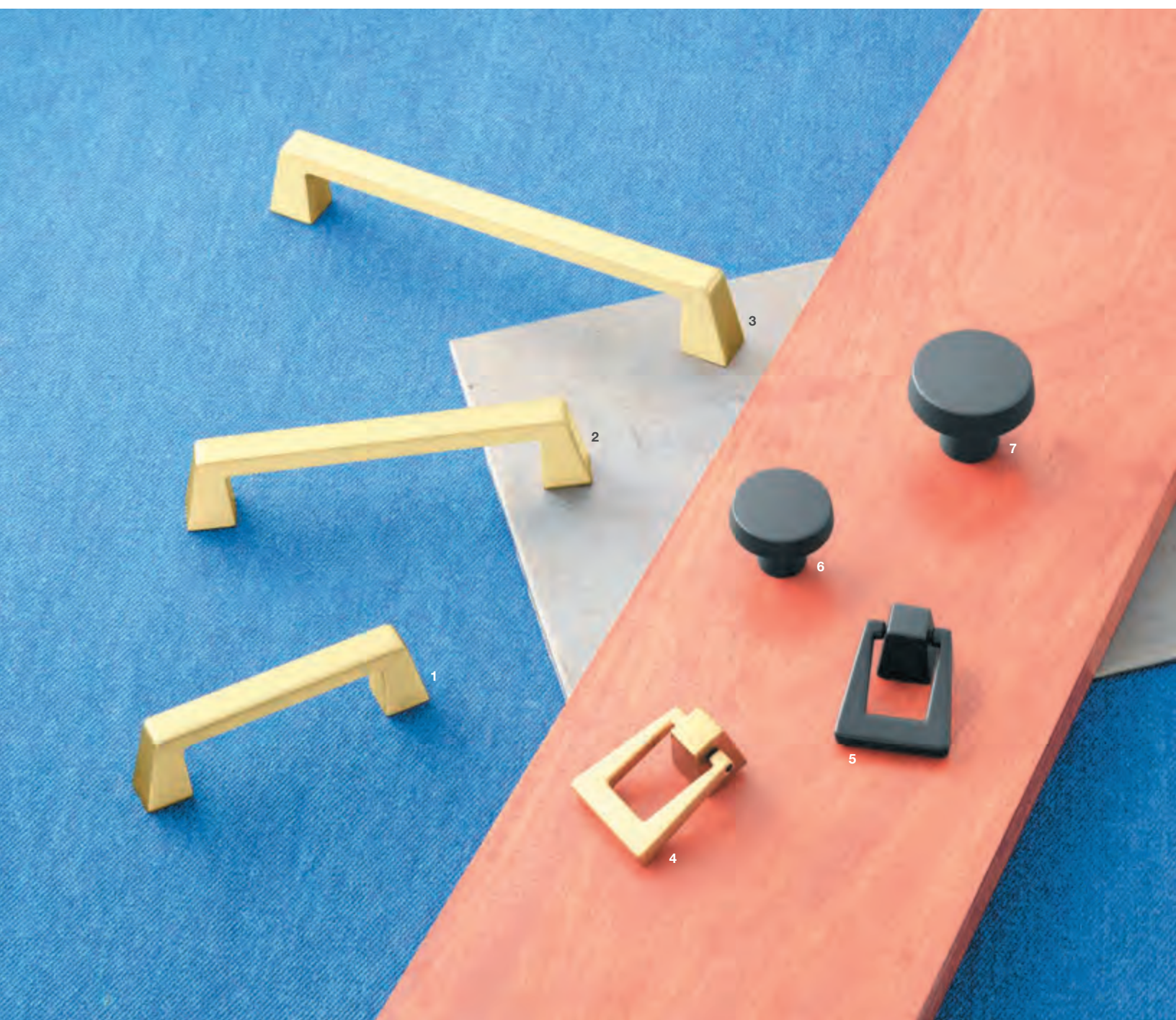

Blackrock

BY AMEROCK

ADA 2-3

	Finish	Material	A	B	C	D	Item No.	SRP/pc.
1	gold champagne	Zinc	95	27	76 (3")	14	133.53.062	\$11.08
2	gold champagne	Zinc	151	30	128	16	133.53.064	\$14.23
3	gold champagne	Zinc	184	32	160	16	133.53.065	\$17.59
4	gold champagne	Zinc	-	-	-	-	133.53.061	\$12.32
5	black bronzed	Zinc	-	-	-	-	133.50.652	\$10.52
6	black bronzed	Zinc	33	-	27	-	133.50.223	\$9.50
7	black bronzed	Zinc	44	-	33	-	133.50.224	\$11.88

Note

Supplied with 1" mounting screws. Refer to page 264 for matching appliance pulls.

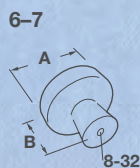
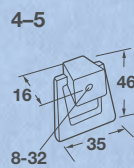
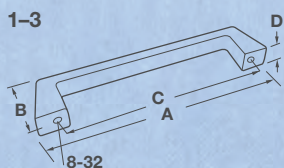



Kane

BY AMEROCK

ADA 5-10

	Finish	Material	A	B	C	D	Item No.	SRP/pc.
1	oil-rubbed bronze	Zinc	-	-	-	-	133.50.140	\$14.06
2	satin nickel	Zinc	-	-	-	-	133.50.141	\$14.06
3	oil-rubbed bronze	Zinc	-	-	-	-	133.50.609	\$9.50
4	satin nickel	Zinc	-	-	-	-	133.50.610	\$9.50
5	oil-rubbed bronze	Zinc	113	29	96	16	133.50.342	\$11.08
6	oil-rubbed bronze	Zinc	144	30	128	17	133.50.340	\$12.66
7	oil-rubbed bronze	Zinc	178	32	160	17	133.50.341	\$14.23
8	satin nickel	Zinc	178	32	160	17	133.50.344	\$14.23
9	satin nickel	Zinc	144	30	128	17	133.50.343	\$12.66
10	satin nickel	Zinc	113	29	96	16	133.50.345	\$11.08

Note
Supplied with 1" mounting screws.

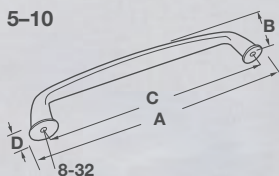
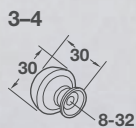
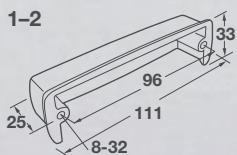



Inspirations

BY AMEROCK

	Finish	Material	Item No.	SRP/pc.
1	wrought iron dark	Zinc	133.50.293	\$9.50
2	satin nickel	Zinc	133.50.299	\$9.50
3	oil-rubbed bronze	Zinc	133.50.297	\$9.50
4	black matt	Zinc	133.50.295	\$9.50
5	weathered nickel	Zinc	133.50.300	\$9.50
6	wrought iron dark	Zinc	133.50.315	\$9.50
7	black matt	Zinc	133.50.317	\$9.50
8	oil-rubbed bronze	Zinc	133.50.319	\$9.50
9	weathered nickel	Zinc	133.50.322	\$9.50
10	satin nickel	Zinc	133.50.321	\$9.50

Note
Supplied with 1" mounting screws.

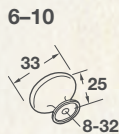
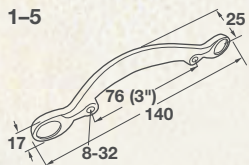



Conrad/ Inspirations

BY AMEROCK

Finish	Material	Item No.	SRP/pc.
1 oil-rubbed bronze	Zinc	133.50.251	\$9.50
2 satin nickel	Zinc	133.50.252	\$9.69
3 oil-rubbed bronze	Zinc	133.50.301	\$7.29
4 satin nickel	Zinc	133.50.302	\$7.29
5 black matt	Zinc	133.50.294	\$9.12
6 satin nickel	Zinc	133.50.298	\$9.12
7 oil-rubbed bronze	Zinc	133.50.296	\$9.12
8 black matt	Zinc	133.50.316	\$6.40
9 satin nickel	Zinc	133.50.320	\$6.40

Note
Supplied with 1" mounting screws.

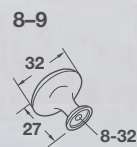
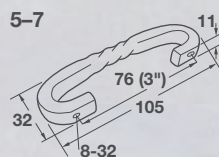
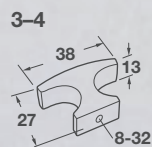
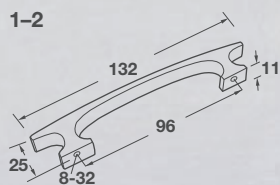



Nature's Splendor

BY AMEROCK

	Finish	Material	Item No.	SRP/pc.
1	oil-rubbed bronze	Zinc	133.50.354	\$9.50
2	satin nickel	Zinc	133.50.355	\$7.85
3	weathered nickel	Zinc	133.50.356	\$9.50
4	oil-rubbed bronze	Zinc	133.50.615	\$6.31
5	satin nickel	Zinc	133.50.616	\$7.02
6	weathered nickel	Zinc	133.50.617	\$6.31

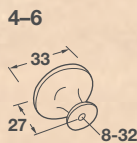
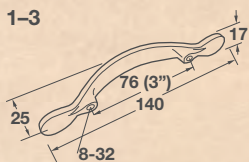

REVIVAL

Whether it is Greek columns or the Gothic rose window, revival styles continue to add signature elements to many designs. In deco, revival style details include ornate scroll work or the hammered Spanish “clavos” or nail heads. Materials run the gamut from a hand or cast iron to a polished gold filigree.







Revival

ALLISON BY AMEROCK - 3-6

	Finish	Material	A	C	Item No.	SRP/pc.
1	oil-rubbed bronze	Zinc	118	96	125.67.351	\$4.55
2	oil-rubbed bronze	Zinc	150	128	125.67.352	\$5.70
3	oil-rubbed bronze	Zinc	-	-	133.50.155	\$6.31
4	satin nickel	Zinc	-	-	133.50.158	\$6.31
5	satin nickel	Zinc	-	-	133.50.220	\$5.71
6	oil-rubbed bronze	Zinc	-	-	133.50.214	\$5.71

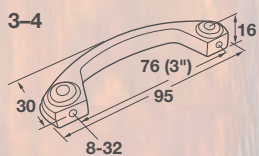
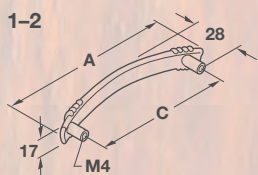

Note
Supplied with 1" mounting screws.

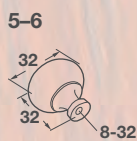

Note
Supplied with 1" mounting screws.



Revitalize

BY AMEROCK

ADA 4-9

	Finish	Material	A	B	C	D	Item No.	SRP/pc.
1	oil-rubbed bronze	Zinc	-	-	-	-	133.50.628	\$9.50
2	oil-rubbed bronze	Zinc	-	-	-	-	133.50.629	\$9.50
3	oil-rubbed bronze	Zinc	94	35	76(3")	14	133.50.359	\$9.50
4	oil-rubbed bronze	Zinc	110	37	96	16	133.50.360	\$12.66
5	oil-rubbed bronze	Zinc	143	40	128	17	133.50.357	\$14.23
6	oil-rubbed bronze	Zinc	173	41	160	19	133.50.358	\$15.84
7	gold champagne	Zinc	173	41	160	19	133.50.366	\$15.84
8	gold champagne	Zinc	143	40	128	17	133.50.365	\$14.23
9	gold champagne	Zinc	110	37	96	16	133.50.369	\$12.66
10	gold champagne	Zinc	94	35	76(3")	14	133.50.368	\$9.50

Note

Supplied with 1" mounting screws. Refer to page 263 for matching appliance pulls.

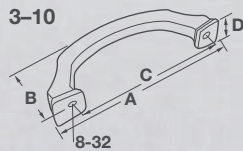
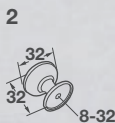
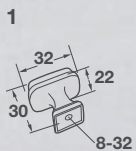



Revitalize

BY AMEROCK

ADA 2-4

	Finish	Material	A	B	C	D	Item No.	SRP/pc.
1	satin nickel	Zinc	94	35	76(3")	14	133.50.363	\$9.50
2	satin nickel	Zinc	110	37	96	16	133.50.364	\$12.66
3	satin nickel	Zinc	143	40	128	17	133.50.361	\$14.23
4	satin nickel	Zinc	173	41	160	19	133.50.362	\$15.84
5	gold champagne	Zinc	-	-	-	-	133.50.626	\$9.50
6	gold champagne	Zinc	-	-	-	-	133.50.627	\$9.50
7	satin nickel	Zinc	-	-	-	-	133.50.630	\$9.50
8	satin nickel	Zinc	-	-	-	-	133.50.631	\$9.50

Note

Supplied with 1" mounting screws. Refer to page 263 for matching appliance pulls.

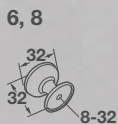
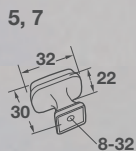
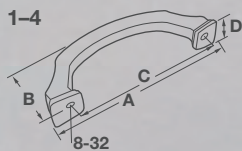



Revitalize

BY AMEROCK

ADA 1-3, 5-8

	Finish	Material	A	B	C	D	Item No.	SRP/pc.
1	black bronzed	Zinc	173	41	160	19	133.53.202	\$17.59
2	black bronzed	Zinc	143	40	128	17	133.53.201	\$14.23
3	black bronzed	Zinc	110	37	96	16	133.53.200	\$12.66
4	black bronzed	Zinc	94	35	76 (3")	14	133.53.199	\$9.50
5	polished nickel	Zinc	173	41	160	19	133.53.210	\$17.59
6	polished nickel	Zinc	143	40	128	17	133.53.209	\$14.23
7	polished nickel	Zinc	110	37	96	16	133.53.208	\$12.66
8	polished nickel	Zinc	94	35	76 (3")	14	133.53.207	\$9.50
9	polished nickel	Zinc	-	-	-	-	133.53.205	\$9.50
10	polished nickel	Zinc	-	-	-	-	133.53.206	\$9.50
11	black bronzed	Zinc	-	-	-	-	133.53.197	\$9.50
12	black bronzed	Zinc	-	-	-	-	133.53.198	\$9.50

Note
Supplied with 1" mounting screws. Refer to page 263 for matching appliance pulls.

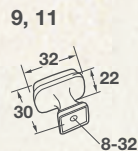
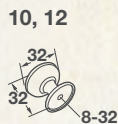
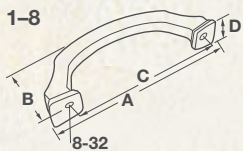

Dimensions in mm unless otherwise noted. Prices subject to change.



Wells

BY AMEROCK

	Finish	Material	A	B	C	D	Item No.	SRP/pc.
1	oil-rubbed bronze	Zinc	122	32	96	22	133.50.399	\$19.20
2	oil-rubbed bronze	Zinc	194	40	160	24	133.50.398	\$22.65
3	polished nickel	Zinc	194	40	160	24	133.50.601	\$19.81
4	polished nickel	Zinc	122	32	96	22	133.50.602	\$17.28
5	polished nickel	Zinc	-	-	-	-	133.50.647	\$12.96
6	oil-rubbed bronze	Zinc	-	-	-	-	133.50.645	\$13.52

Note
Supplied with 1" mounting screws.

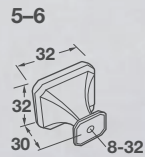
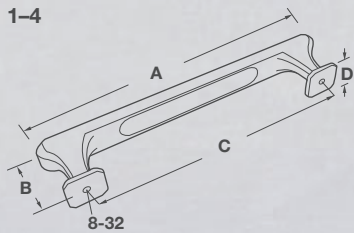



Wells

BY AMEROCK

	Finish	Material	A	B	C	D	Item No.	SRP/pc.
1	gunmetal	Zinc	-	-	-	-	133.50.643	\$14.40
2	satin nickel	Zinc	-	-	-	-	133.50.649	\$12.96
3	satin nickel	Zinc	122	32	96	22	133.50.605	\$17.28
4	satin nickel	Zinc	157	37	128	22	133.50.603	\$18.51
5	satin nickel	Zinc	194	40	160	24	133.50.604	\$20.27
6	gunmetal	Zinc	194	40	160	24	133.50.395	\$22.65
7	gunmetal	Zinc	157	37	128	22	133.50.394	\$21.14
8	gunmetal	Zinc	122	32	96	22	133.50.396	\$19.20

Note
Supplied with 1" mounting screws.

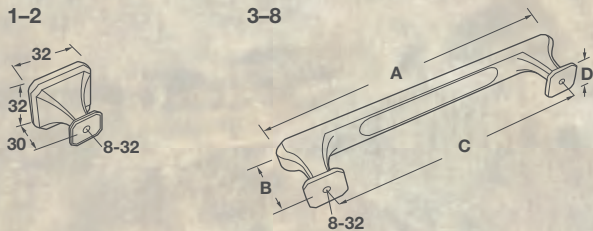

CLASSIC

Steadfast. Sacred and cherished. Classic or traditional style is embraced as a safeguard against the mercurial fickleness of fads. Classic deco standards include: beveled edges, spherical turns and bail pulls. Materials include solid brass, pewter, nickel and bronze.







Artisan

BY HÄFELE

	Finish	Material	A	B	C	D	Item No.	SRP/pc.
1	antique brass	Zinc	32	30	–	16	125.86.101	\$9.77
2	antique brass	Zinc	48	37	–	19	125.86.102	\$18.33
3	oil-rubbed bronze	Zinc	32	30	–	16	125.86.303	\$13.18
4	oil-rubbed bronze	Zinc	48	37	–	19	125.86.304	\$21.04
5	oil-rubbed bronze	Zinc	108	30	96	11	125.87.334	\$16.83
6	oil-rubbed bronze	Zinc	150	18	128	45	125.87.354	\$23.16
7	antique brass	Zinc	150	18	128	45	125.87.152	\$18.03
8	antique brass	Zinc	225	55	8"	24	125.87.102	\$69.60
9	antique brass	Zinc	148	38	128	16	125.87.101	\$24.76
10	antique brass	Zinc	108	30	96	11	125.87.132	\$9.77
11	antique brass	Zinc	88	30	3"	11	125.87.131	\$10.23

Note
Supplied with mounting screws. Refer to page 257 for matching appliance pulls.

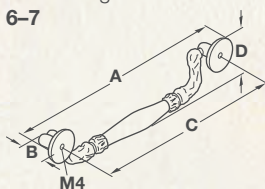
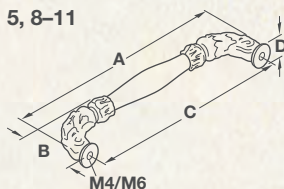
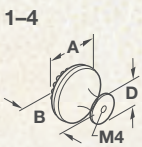



Artisan

BY HÄFELE

	Finish	Material	A	B	C	D	Item No.	SRP/pc.
1	oil-rubbed bronze	Zinc	88	30	3"	11	125.87.333	\$15.98
2	oil-rubbed bronze	Zinc	148	38	128	16	125.87.305	\$30.42
3	oil-rubbed bronze	Zinc	225	55	8"	24	125.87.306	\$83.68
4	pewter	Zinc	225	55	8"	24	125.87.902	\$69.54
5	pewter	Zinc	148	38	128	16	125.87.901	\$22.92
6	pewter	Zinc	150	18	128	45	125.87.952	\$18.03
7	pewter	Zinc	108	30	96	11	125.87.932	\$9.77
8	pewter	Zinc	88	30	3"	11	125.87.931	\$9.43
9	pewter	Zinc	32	30	-	16	125.86.901	\$9.49
10	pewter	Zinc	48	37	-	19	125.86.902	\$18.78

Note
Supplied with mounting screws. Refer to page 257 for matching appliance pulls.

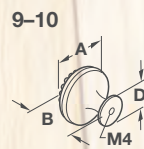
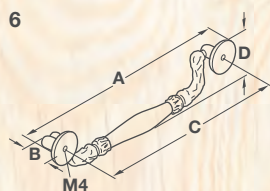
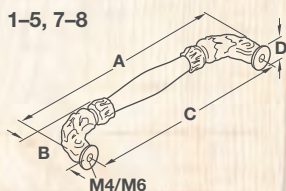

Dimensions in mm unless otherwise noted. Prices subject to change.



Bordeaux

	Finish	Material	A	B	C	D	Item No.	SRP/pc.
1	oil-rubbed bronze	Iron	-	-	-	-	125.88.343	\$30.70
2	oil-rubbed bronze	Iron	-	-	-	-	125.88.355	\$25.94
3	oil-rubbed bronze	Iron	116	34	96	20	125.88.311	\$12.95
4	oil-rubbed bronze	Iron	153	40	128	25	125.88.312	\$26.54
5	oil-rubbed bronze	Iron	229	52	8"	28	125.88.314	\$42.18
6	pewter	Iron	229	52	8"	28	125.88.904	\$32.60
7	pewter	Iron	153	40	128	25	125.88.902	\$18.76
8	pewter	Iron	116	34	96	20	125.88.901	\$11.79
9	pewter	Iron	-	-	-	-	125.88.951	\$16.69
10	pewter	Iron	-	-	-	-	125.88.942	\$28.96

Note
Supplied with mounting screws. Refer to page 257 for matching appliance pulls.

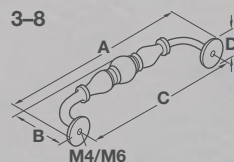
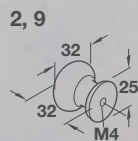
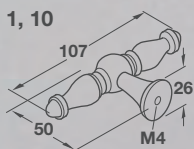



Classic

	Finish	Material	Item No.	SRP/pc.
1	polished	Brass	121.88.868	\$14.82
2	polished chrome	Brass	121.88.260	\$15.51
3	stainless steel	Brass	121.88.662	\$14.98
4	stainless steel look	Brass	137.42.606	\$14.52
5	antique bronze	Zinc	122.18.129	\$13.48
6	dark oil-rubbed bronze	Zinc	120.17.370	\$8.86
7	oil-rubbed bronze	Zinc	120.70.303	\$19.33
8	antique brass	Brass	125.16.101	\$16.82

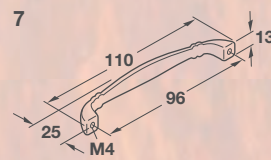
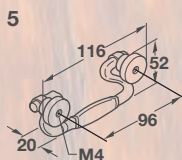
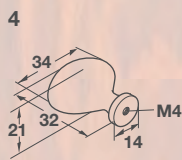
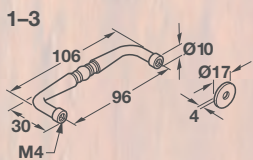

Dimensions in mm unless otherwise noted. Prices subject to change.



Classic

	Finish	Material	Item No.	SRP/pc.
1	rustic brass	Brass	125.73.113	\$7.49
2	rustic brass	Brass	125.72.102	\$19.01
3	antique brass	Zinc	125.28.100	\$2.00
4	antique english	Zinc	120.62.110	\$5.03
5	antique english	Zinc	118.30.103	\$3.55
6	stainless steel	Brass	155.01.540	\$9.02
7	polished chrome	Brass	155.01.543	\$8.84
8	antique english	Zinc	107.13.112	\$4.03
9	oil-rubbed bronze	Zinc	110.93.192	\$3.78
10	oil-rubbed bronze	Zinc	110.93.191	\$4.89

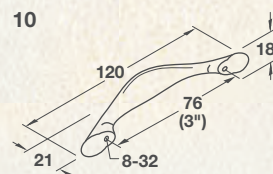
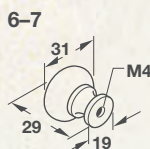
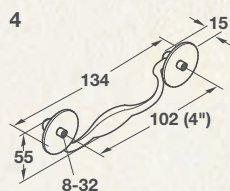
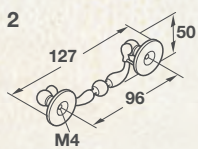
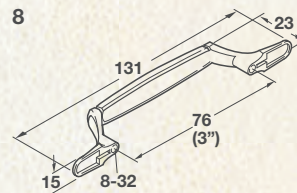
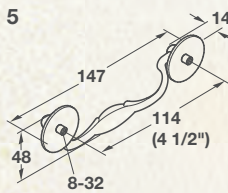
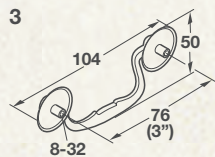
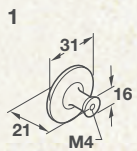

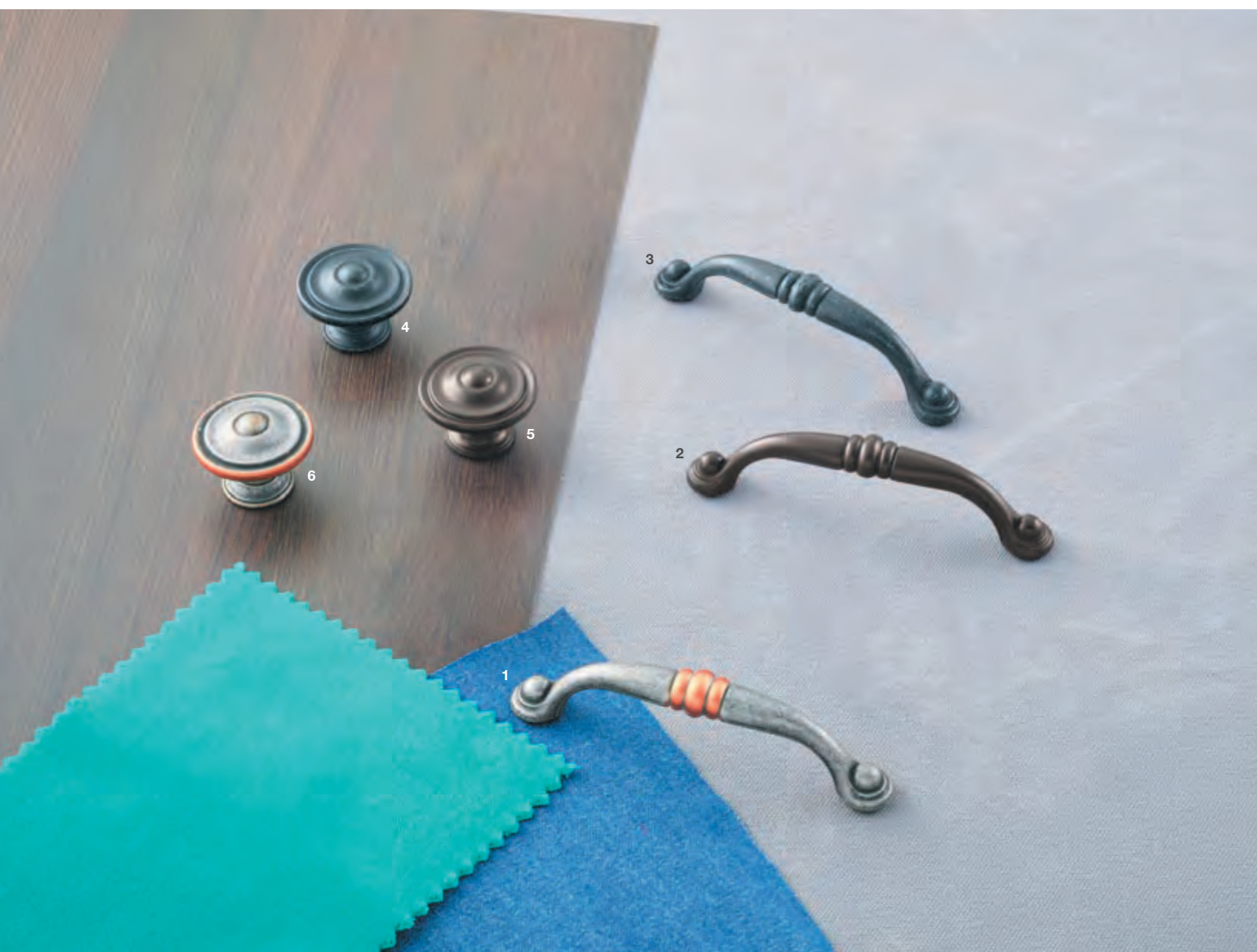

Classic

	Finish	Material	Item No.	SRP/pc.
1	pewter & copper	Zinc	121.90.902	\$6.94
2	dark oil-rubbed bronze	Zinc	121.90.301	\$6.79
3	black antique	Zinc	121.90.302	\$6.14
4	black antique	Zinc	134.33.320	\$5.05
5	dark oil-rubbed bronze	Zinc	134.33.321	\$5.64
6	pewter & copper	Zinc	134.33.940	\$6.81

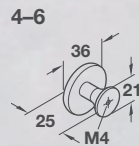
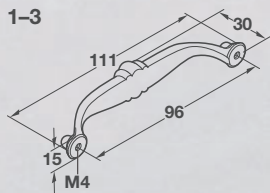



Classic

	Finish	Material	A	B	D	Item No.	SRP/pc.
1	polished chrome	Zinc	-	-	-	125.61.251	\$2.04
2	stainless steel look	Zinc	-	-	-	125.61.051	\$2.41
3	dark oil-rubbed bronze	Zinc	-	-	-	125.61.351	\$2.04
4	dark oil-rubbed bronze	Zinc	-	-	-	121.46.350	\$3.59
5	stainless steel look	Zinc	-	-	-	134.45.602	\$3.56
6	stainless steel	Zinc	35	35	23	137.45.002	\$3.27
7	dark oil-rubbed bronze	Zinc	30	30	19	137.45.331	\$2.42

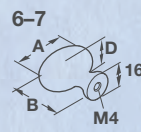
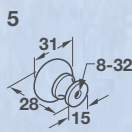
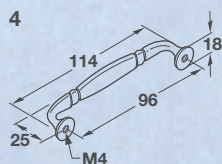
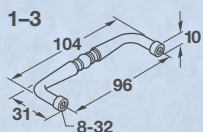



Granby

BY AMEROCK

ADA 1-7

	Finish	Material	A	B	C	D	Item No.	SRP/pc.
1	oil-rubbed bronze	Zinc	106	37	96	16	133.50.285	\$7.92
2	oil-rubbed bronze	Zinc	141	40	128	19	133.50.283	\$9.50
3	satin nickel	Zinc	106	37	96	16	133.50.292	\$7.92
4	satin nickel	Zinc	141	40	128	19	133.50.290	\$9.50
5	polished nickel	Zinc	106	37	96	16	133.50.289	\$7.92
6	polished nickel	Zinc	141	40	128	19	133.50.286	\$9.50
7	polished nickel	Zinc	175	44	160	22	133.50.287	\$14.23
8	polished nickel	Zinc	86	33	76 (3")	14	133.50.288	\$4.74
9	satin nickel	Zinc	86	33	76 (3")	14	133.50.291	\$4.74
10	oil-rubbed bronze	Zinc	86	33	76 (3")	14	133.50.284	\$4.74

Note
Supplied with 1" mounting screws.

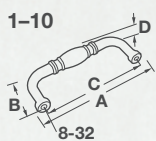



Blythe

BY AMEROCK

	Finish	Material	A	B	C	D	Item No.	SRP/pc.
1	satin nickel	Zinc	92	32	76 (3")	13	133.50.181	\$6.48
2	satin nickel	Zinc	114	35	96	16	133.50.182	\$7.61
3	satin nickel	Zinc	146	40	128	17	133.50.180	\$10.05
4	polished nickel	Zinc	179	44	160	21	133.50.177	\$11.18
5	polished nickel	Zinc	76	-	-	24	133.50.235	\$9.83
6	satin nickel	Zinc	67	-	-	21	133.50.236	\$6.38

Note
Supplied with 1" mounting screws.

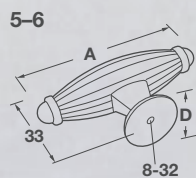
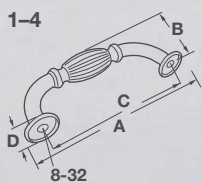



Blythe

BY AMEROCK

	Finish	Material	A	B	C	D	Item No.	SRP/pc.
1	polished nickel	Zinc	-	-	-	-	133.50.234	\$4.76
2	polished nickel	Zinc	92	32	76 (3")	13	133.50.178	\$6.43
3	polished nickel	Zinc	114	35	96	16	133.50.179	\$7.72
4	polished nickel	Zinc	146	40	128	17	133.50.176	\$9.66
5	oil-rubbed bronze	Zinc	146	40	128	17	133.50.173	\$10.05
6	oil-rubbed bronze	Zinc	114	35	96	16	133.50.175	\$7.57
7	oil-rubbed bronze	Zinc	92	32	76 (3")	13	133.50.174	\$6.48
8	oil-rubbed bronze	Zinc	-	-	-	-	133.50.233	\$6.38

Note
Supplied with 1" mounting screws.

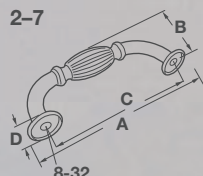
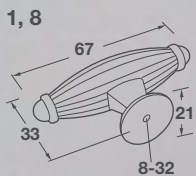

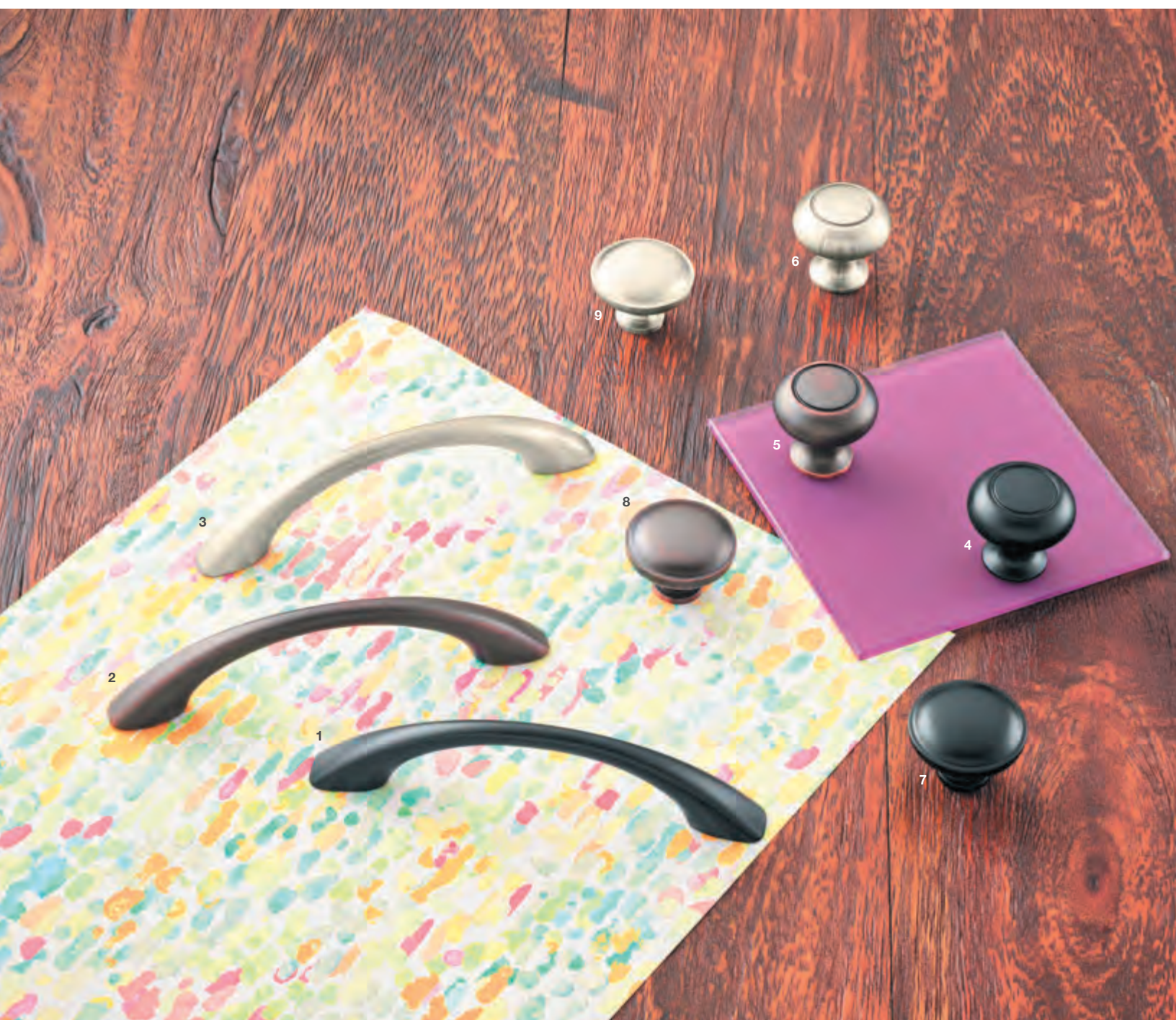

Allison

BY AMEROCK

Finish

- 1 black matt
- 2 oil-rubbed bronze
- 3 satin nickel
- 4 black matt
- 5 oil-rubbed bronze
- 6 satin nickel
- 7 black matt
- 8 oil-rubbed bronze
- 9 satin nickel

Material

- Zinc
- Zinc
- Zinc
- Zinc
- Zinc
- Zinc
- Zinc
- Zinc
- Zinc

Item No.

- 133.50.154
- 133.50.156
- 133.50.160
- 133.50.206
- 133.50.210
- 133.50.216
- 133.50.209
- 133.50.213
- 133.50.219

SRP/pc.

- \$5.84
- \$5.24
- \$5.24
- \$5.28
- \$5.27
- \$4.51
- \$2.90
- \$4.74
- \$4.74

Note

Supplied with 1" mounting screws.

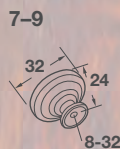
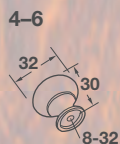
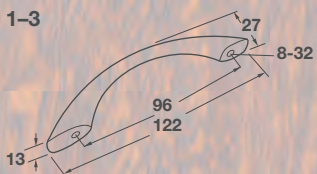



Winsome NEW

BY AMEROCK

- Finish**
- 1 oil-rubbed bronze
 - 2 matt black
 - 3 champagne bronze
 - 4 satin nickel
 - 5 polished chrome

- Material**
- Zinc
 - Zinc
 - Zinc
 - Zinc
 - Zinc
 - Zinc
 - Zinc
 - Zinc
 - Zinc

A	C	Item No.	SRP/pc.
-	-	133.53.411	\$17.59
-	-	133.53.359	\$14.40
-	-	133.53.299	\$15.85
-	-	133.53.470	\$15.85
-	-	133.53.416	\$17.59
135	96	133.53.471	\$18.99
165	128	133.53.472	\$25.34
230	192	133.53.473	\$35.21
262	224	133.53.474	\$38.78

Note
Supplied with mounting screws.

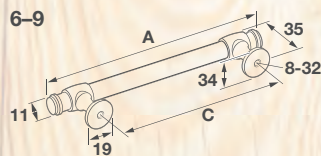
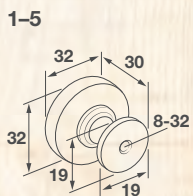

Dimensions in mm unless otherwise noted. Prices subject to change.



Winsome NEW

BY AMEROCK

	Finish	Material	A	C	Item No.	SRP/pc.
1	champagne bronze	Zinc	135	96	133.53.300	\$18.99
2	champagne bronze	Zinc	165	128	133.53.301	\$25.34
3	champagne bronze	Zinc	230	192	133.53.302	\$35.21
4	champagne bronze	Zinc	262	224	133.53.303	\$38.78
5	oil-rubbed bronze	Zinc	135	96	133.53.412	\$21.11
6	oil-rubbed bronze	Zinc	165	128	133.53.413	\$28.18
7	oil-rubbed bronze	Zinc	230	192	133.53.414	\$35.21
8	oil-rubbed bronze	Zinc	262	224	133.53.415	\$38.78

Note
Supplied with mounting screws.

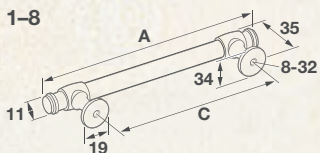



Winsome NEW

BY AMEROCK

	Finish	Material	A	C	Item No.	SRP/pc.
1	matt black	Zinc	135	96	133.53.360	\$18.99
2	matt black	Zinc	165	128	133.53.361	\$25.34
3	matt black	Zinc	230	192	133.53.362	\$35.21
4	matt black	Zinc	262	224	133.53.363	\$38.78
5	polished chrome	Zinc	135	96	133.53.417	\$21.11
6	polished chrome	Zinc	165	128	133.53.418	\$28.18
7	polished chrome	Zinc	230	192	133.53.419	\$35.21
8	polished chrome	Zinc	262	224	133.53.420	\$38.78

Note
Supplied with mounting screws.

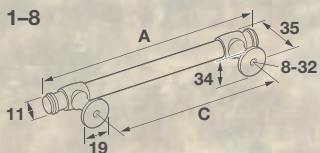

Dimensions in mm unless otherwise noted. Prices subject to change.