









SCAN FOR PRICING!



(2) upper sections pull up and away, for easy access to the items stored beneath



**4WTMD-24HSC-1**  
Tiered Maxx Drawer



Comes with (8) short dividers,  
(5) long dividers and (26) clips

**Tiered MAXX Drawer w/ BLUMOTION Soft-Close**

PRODUCT	DESCRIPTION	DIMS	MCO	CAB	FINISH	SLP
4WTMD-24HSC-1	Tiered Maxx Drawer	21" (533 mm) W x 21-17/32" (547 mm) D x 4-11/32" (111 mm) H	21" (533 mm)	B24	Maple	\$424.40





SCAN FOR PRICING!



- Designed for 30" and 36" base cabinet drawers
- Complete drawer system, just add your drawer front
- Easy installation
- Natural maple construction with semi-gloss finish
- Full-extension, BLUM soft-close undermount slides
- (3) drawer compartments
- Sliding top tray is designed for use with 4WCT, 4WUT and 4WKB inserts (sold separately, pgs. 214-220)
- Mounts to cabinet drawer front, rear and sidewalls
- Figure 8 door mount brackets
- US Patent No. D843,791
- TSCA Title VI compliant



4WTCDD-36HSC-1



**4WTCDD-30HSC-1 & 4WTCDD-724HFLSC-1**  
Tiered Deep Drawers  
(30" version shown)



Top tier compatible with our trimmable inserts



For video visit:  
[rev-a-shelf.com/videos](https://rev-a-shelf.com/videos)

#### Full Access Tiered Deep Drawer w/ BLUMOTION Soft-Close

PRODUCT	DESCRIPTION	DIMS	MCO	CAB	FINISH	SLP
4WTCDD-724HFLSC-1	Tiered Deep Drawer	28-1/2" (724 mm) W x 22-3/16" (564 mm) D x 8-1/32" (204 mm) H	28-1/2" (724 mm)	FLB30	Maple	\$561.00
4WTCDD-876HFLSC-1	Tiered Deep Drawer	34-1/2" (876 mm) W x 22-3/16" (564 mm) D x 8-1/32" (204 mm) H	34-1/2" (876 mm)	FLB36	Maple	\$581.30

#### Face Frame Tiered Deep Drawer w/ BLUMOTION Soft-Close

4WTCDD-30HSC-1	Tiered Deep Drawer	27" (686 mm) W x 22-1/4" (565 mm) D x 8-1/32" (204 mm) H	27" (686 mm)	FFB30	Maple	\$497.50
4WTCDD-36HSC-1	Tiered Deep Drawer	33" (838 mm) W x 22-1/4" (565 mm) D x 8-1/32" (204 mm) H	33" (838 mm)	FFB36	Maple	\$519.80



SCAN FOR PRICING!

# Charging Drawer

## 4WCDB Series

Waste

Blind Corner

Sink

Base

Tail

Drawer

Wall

Vanity

Closet

Lazy Susan

LED Lighting



- Designed for 18" base cabinet drawers
- Just add your drawer front
- Natural maple construction with semi-gloss finish
- Full-extension, BLUM soft-close undermount slides
- (2) 120V plugs and (2) 2.1 amp USB ports
- Tamper resistant outlets
- Max Current: AC: 12 amps @ 120VAC; USB 2.1 amp & 5VDC
- UL recognized to UL962/CSA-C22.2 No. 0-10
- Power cord with NEMA 5 - 15 plug
- Integrated cord guide to ensure safe operation
- Figure 8 door mounting brackets
- Shock absorbent mat, black
- Overall safety of this product is determined by its end use
- TSCA Title VI compliant

4WCDB-18HFLSC-1



**4WCDB-18HSC-1**  
Charging Drawer



Integrated cord guide to ensure safe operation mounts to cabinet side and rear wall



For video visit:  
[rev-a-shelf.com/videos](http://rev-a-shelf.com/videos)

### Full Access Charging Drawer w/ BLUMOTION Soft-Close

PRODUCT	DESCRIPTION	DIMS	MCO	CAB	FINISH	SLP
4WCDB-18HFLSC-1	Charging Drawer	16-1/2" (419 mm) W x 22-7/16" (570 mm) D x 4-5/16" (110 mm) H	16-1/2" (419 mm)	FLB18	Maple	\$600.60

### Face Frame Charging Drawer w/ BLUMOTION Soft-Close

4WCDB-18HSC-1	Charging Drawer	15" (381 mm) W x 22-3/4" (578 mm) D x 4-5/16" (110 mm) H	15" (381 mm)	FFB18	Maple	\$604.50
---------------	-----------------	--	--------------	-------	-------	----------

# 4WTCD Series

## Tiered Cutlery Drawer



SCAN FOR PRICING!



4WTCD-18HSC-1

**blum**

- Designed for 15", 18", 21" and 24" base cabinet drawers
- Complete drawer system, just add your drawer front
- Easy installation
- Natural maple construction with semi-gloss finish
- Full-extension, BLUM soft-close undermount slides
- Drawer features up to (7) compartments
- Sliding top tray features up to (7) compartments
- Mounts to cabinet drawer front, rear and side walls
- Figure 8 door mount brackets
- TSCA Title VI compliant

**JUST ADD  
YOUR OWN  
DRAWER  
FRONT!**



For video visit:  
[rev-a-shelf.com/videos](https://rev-a-shelf.com/videos)





SCAN FOR PRICING!



**4WTCD-15H-1 & 4WTCD-15HSC-1**  
Face Frame Tiered Cutlery Drawer  
(15" version shown)



**4WTCD-18H-1 & 4WTCD-18HSC-1**  
Face Frame Tiered Cutlery Drawer  
(18" version shown)



**4WTCD-21H-1 & 4WTCD-21HSC-1**  
Face Frame Tiered Cutlery Drawer  
(21" version shown)



**4WTCD-24H-1 & 4WTCD-24HSC-1**  
Face Frame Tiered Cutlery Drawer  
(24" version shown)



**4WTCD-343HFL-1 & 4WTCD-343HFLSC-1**  
Full Access Tiered Cutlery Drawer  
(15" version shown)



**4WTCD-419HFL-1 & 4WTCD-419HFLSC-1**  
Full Access Tiered Cutlery Drawer  
(18" version shown)



**4WTCD-495HFL-1 & 4WTCD-495HFLSC-1**  
Full Access Tiered Cutlery Drawer  
(21" version shown)



**4WTCD-572HFL-1 & 4WTCD-572HFLSC-1**  
Full Access Tiered Cutlery Drawer  
(24" version shown)

**NOW YOU HAVE THE CHOICE!**  
AVAILABLE WITH **BLUM®** CONCEALED SLIDES...OR PROVIDE YOUR OWN!  
Designed to be used with **BLUMOTION 563H533** or **Grass Elite 7523-16/550/533** concealed slides.

Full Access Tiered Cutlery Drawer, w/ BLUMOTION Soft-Close						
PRODUCT	DESCRIPTION	DIMS	MCO	CAB	FINISH	SLP
4WTCD-343HFLSC-1	Tiered Cutlery Drawer	13-1/2" (343 mm) W x 21-5/8" (550 mm) D x 4-5/16" (110 mm) H	13-1/2" (343 mm)	FLB15	Maple	\$291.45
4WTCD-419HFLSC-1	Tiered Cutlery Drawer	16-1/2" (419 mm) W x 21-5/8" (550 mm) D x 4-5/16" (110 mm) H	16-1/2" (419 mm)	FLB18	Maple	\$319.00
4WTCD-495HFLSC-1	Tiered Cutlery Drawer	19-1/2" (495 mm) W x 21-5/8" (550 mm) D x 4-5/16" (110 mm) H	19-1/2" (495 mm)	FLB21	Maple	\$345.25
4WTCD-572HFLSC-1	Tiered Cutlery Drawer	22-1/2" (572 mm) W x 21-5/8" (550 mm) D x 4-5/16" (110 mm) H	22-1/2" (572 mm)	FLB24	Maple	\$361.35
Full Access Tiered Cutlery Drawer - No Slides						
4WTCD-343HFL-1	Tiered Cutlery Drawer	13-1/32" (331 mm) W x 21" (533 mm) D x 3-3/4" (95 mm) H	N/A	FLB15	Maple	\$218.95
4WTCD-419HFL-1	Tiered Cutlery Drawer	16-1/32" (407 mm) W x 21" (533 mm) D x 3-3/4" (95 mm) H	N/A	FLB18	Maple	\$252.60
4WTCD-495HFL-1	Tiered Cutlery Drawer	19-1/32" (483 mm) W x 21" (533 mm) D x 3-3/4" (95 mm) H	N/A	FLB21	Maple	\$267.25
4WTCD-572HFL-1	Tiered Cutlery Drawer	22-1/32" (560 mm) W x 21" (533 mm) D x 3-3/4" (95 mm) H	N/A	FLB24	Maple	\$312.35
Face Frame Tiered Cutlery Drawer, w/ BLUMOTION Soft-Close						
4WTCD-15HSC-1	Tiered Cutlery Drawer	12" (305 mm) W x 21-3/4" (552 mm) D x 4-5/16" (110 mm) H	12" (305 mm)	FFB15	Maple	\$273.60
4WTCD-18HSC-1	Tiered Cutlery Drawer	15" (381 mm) W x 21-3/4" (552 mm) D x 4-5/16" (110 mm) H	15" (381 mm)	FFB18	Maple	\$291.75
4WTCD-21HSC-1	Tiered Cutlery Drawer	18" (457 mm) W x 21-3/4" (552 mm) D x 4-5/16" (110 mm) H	18" (457 mm)	FFB21	Maple	\$316.55
4WTCD-24HSC-1	Tiered Cutlery Drawer	21" (533 mm) W x 21-3/4" (552 mm) D x 4-5/16" (110 mm) H	21" (533 mm)	FFB24	Maple	\$338.45
Face Frame Tiered Cutlery Drawer - No Slides						
4WTCD-15H-1	Tiered Cutlery Drawer	11-1/2" (293 mm) W x 21" (533 mm) D x 3-3/4" (95 mm) H	N/A	FFB15	Maple	\$200.40
4WTCD-18H-1	Tiered Cutlery Drawer	14-1/2" (369 mm) W x 21" (533 mm) D x 3-3/4" (95 mm) H	N/A	FFB18	Maple	\$240.25
4WTCD-21H-1	Tiered Cutlery Drawer	17-1/2" (445 mm) W x 21" (533 mm) D x 3-3/4" (95 mm) H	N/A	FFB21	Maple	\$264.65
4WTCD-24H-1	Tiered Cutlery Drawer	20-1/2" (521 mm) W x 21" (533 mm) D x 3-3/4" (95 mm) H	N/A	FFB24	Maple	\$282.60

Waste  
Blind Corner  
Sink  
Base  
Tail  
Drawer  
Wall  
Vanity  
Closet  
Susan  
Lazy  
LED Lighting



SCAN FOR PRICING!



- Designed for 30" and 36" base cabinet drawers
- Complete drawer system, just add your drawer front
- Easy installation
- Natural maple construction with semi-gloss finish
- Full-extension, BLUM soft-close undermount slides
- Drawer features up to (6) compartments and built-in knife organizer
- Sliding top tray features up to (6) compartments
- Mounts to cabinet side and rear wall
- Figure 8 door mounting brackets
- (1) Foil Wrap Insert
- Patented design (US Patent No. D843,791)
- TSCA Title VI compliant



4WTCD-876HFLSC-1



**4WTCD-724HFLSC-1 & 4WTCD-724HFL-1**  
Tiered Combination Drawer  
(Full Access 30" shown)



**4WTCD-36HFLSC-1 & 4WTCD-36HFL-1**  
Tiered Combination Drawer  
(Face Frame 36" shown)



Sliding top tray features up to (6) compartments



For video visit:  
[rev-a-shelf.com/videos](http://rev-a-shelf.com/videos)

### Full Access Tiered Combination Drawer w/ BLUMOTION Soft-Close

PRODUCT	DESCRIPTION	DIMS	MCO	CAB	FINISH	SLP
4WTCD-724HFLSC-1	Tiered Combination Drawer	28-1/2" (724 mm) W x 22-3/16" (564 mm) D x 4-7/16" (113 mm) H	28-1/2" (724 mm)	FLB30	Maple	\$554.50
4WTCD-876HFLSC-1	Tiered Combination Drawer	34-1/2" (876 mm) W x 22-3/16" (564 mm) D x 4-7/16" (113 mm) H	34-1/2" (876 mm)	FLB36	Maple	\$606.70

### Full Access Tiered Combination Drawer - No Slides

4WTCD-724HFL-1	Tiered Combination Drawer	28-1/32" (712 mm) W x 21" (533 mm) D x 3-3/4" (95 mm) H		FLB30	Maple	\$399.05
4WTCD-876HFL-1	Tiered Combination Drawer	34-1/32" (864 mm) W x 21" (533 mm) D x 3-3/4" (95 mm) H		FLB36	Maple	\$431.80

### Face Frame Tiered Combination Drawer w/ BLUMOTION Soft-Close

4WTCD-30HSC-1	Tiered Combination Drawer	27" (686 mm) W x 22-1/4" (565 mm) D x 4-5/16" (110 mm) H	27" (686 mm)	FFB30	Maple	\$538.95
4WTCD-36HSC-1	Tiered Combination Drawer	33" (838 mm) W x 22-1/4" (565 mm) D x 4-5/16" (110 mm) H	33" (838 mm)	FFB36	Maple	\$592.20

### Face Frame Tiered Combination Drawer - No Slides

4WTCD-30H-1	Tiered Combination Drawer	26-1/2" (674 mm) W x 21" (533 mm) D x 3-3/4" (95 mm) H		FFB30	Maple	\$334.65
4WTCD-36H-1	Tiered Combination Drawer	32-1/2" (826 mm) W x 21" (533 mm) D x 3-3/4" (95 mm) H		FFB36	Maple	\$387.45





SCAN FOR PRICING!

# Tiered K-Cup Drawer

## 4WTCD Series



- Designed for face frame 18" base cabinet drawers
- Complete drawer system, just add your drawer front
- Easy installation
- Natural maple construction with semi-gloss finish
- Full-extension, BLUM soft-close undermount slides
- Drawer features (8) compartments
- Sliding top tray holds (40) K-Cups
- Mounts to cabinet side and rear wall
- Figure 8 door mounting brackets
- Patented design (US Patent No. D789,750S1)
- TSCA Title VI compliant



4WTCD-18HSC-KCUP-1 & 4WTCD-18H-KCUP-1  
Tiered K-Cup Drawer



For video visit:  
[rev-a-shelf.com/videos](http://rev-a-shelf.com/videos)

### Face Frame Tiered K-Cup Drawer w/ BLUMOTION Soft-Close

PRODUCT	DESCRIPTION	DIMS	MCO	CAB	FINISH	SLP
4WTCD-18HSC-KCUP-1	Tiered K-Cup Drawer	15" (381 mm) W x 21-3/4" (552 mm) D x 4-5/16" (110 mm) H	15" (381 mm)	FFB18	Maple	\$314.05

### Face Frame Tiered K-Cup Drawer - No Slides

4WTCD-18H-KCUP-1	K-Cup Drawer	14-1/2" (369 mm) W x 21" (533 mm) D x 3-3/4" (95 mm) H		FFB18	Maple	\$243.60
------------------	--------------	--	--	-------	-------	----------



SCAN FOR PRICING!



- Designed for 18" cabinet drawers
- Natural maple construction with semi-gloss finish
- Removable, cut-out cutting board
- Removable, funnel insert
- Odor-reducing stopper
- Full-extension, BLUM soft-close undermount slides
- 5/8" drawer side walls
- Figure 8 door mounting brackets
- Drawer front (NOT) included
- Waste container (NOT) included
- TSCA Title VI compliant



Odor-reducing stopper



Removable food funnel for easy clean-up

4WCCB-419HFLSC-1



For video visit:  
[rev-a-shelf.com/videos](http://rev-a-shelf.com/videos)

**Full Access Cut-Out Cutting Board Drawer w/ TANDEM Slides**

PRODUCT	DESCRIPTION	DIMS	MCO	CAB	FINISH	SLP
4WCCB-419HFLSC-1	Cut-Out Cutting Board Drawer	16-1/2" (419 mm) W x 21-5/8" (550 mm) D x 4-5/16" (110 mm) H	16-1/2" (419 mm)	FLB18	Maple	\$375.85

**Face Frame Cut-Out Cutting Board Drawer w/ TANDEM Slides**

4WCCB-18HSC-1	Cut-Out Cutting Board Drawer	15" (381 mm) W x 21-3/4" (552 mm) D x 4-9/32" (109 mm) H	15" (521 mm)	FFB18	Maple	\$361.90
---------------	------------------------------	--	--------------	-------	-------	----------





SCAN FOR PRICING!

# Combination Knife Holder/Cutting Board Drawer

## 4KCB Series



- Designed for 18", 21" and 24" face frame and 18" full access base cabinet drawers
  - Face Frame fits 1-1/2"
  - Full Access fits 3/4"
- Complete drawer system, just add your drawer front
- Natural maple construction with semi-gloss finish
- Full-extension, BLUM soft-close undermount slides
- Up to (4) compartments and built-in knife organizer
- Mounts to cabinet drawer front, rear and side walls
- Figure 8 door mount brackets
- Built-in locking mechanism
- (1) wood cutting board
- Drawer front (NOT) included
- TSCA Title VI compliant

4KCB-419HFLSC-1



Top tier stores the included cutting board



**4KCB-21HSC-1**  
Combination Drawer  
(21" version shown)



**4KCB-18HSC-1**  
Combination Drawer  
(18" version shown)



For video visit:  
[rev-a-shelf.com/videos](http://rev-a-shelf.com/videos)

### Full Access Combination Knife Holder/ Cutting Board Drawer w/ BLUMOTION Soft-Close

PRODUCT	DESCRIPTION	DIMS	MCO	CAB	FINISH	SLP
4KCB-419HFLSC-1	Combination Drawer	16-1/2" (419 mm) W x 21-5/8" (550 mm) D x 4-3/8" (112 mm) H	16-1/2" (419 mm)	FLB18	Maple	\$369.00

### Combination Knife Holder/ Cutting Board Drawer w/ BLUMOTION Soft-Close

4KCB-18HSC-1	Combination Drawer	15" (381 mm) W x 21-3/4" (552 mm) D x 4-3/8" (112 mm) H	15" (381 mm)	FFB18	Maple	\$357.45
4KCB-21HSC-1	Combination Drawer	18" (457 mm) W x 21-3/4" (552 mm) D x 4-3/8" (112 mm) H	18" (457 mm)	FFB21	Maple	\$401.80
4KCB-24HSC-1	Combination Drawer	21" (533 mm) W x 21-3/4" (552 mm) D x 4-3/8" (112 mm) H	21" (533 mm)	FFB24	Maple	\$424.25

Waste  
Blind Corner  
Sink  
Base  
Tail  
Drawer  
Wall  
Vanity  
Closet  
Susan  
Lazy  
LED Lighting



SCAN FOR PRICING!



- Designed for 12", 15" and 18" vanity base cabinet drawers
- Complete drawer system, just add your drawer front
- Easy installation
- Natural maple construction with semi-gloss finish
- Full-extension, BLUM soft-close undermount slides
- Up to (7) compartments and up to (5) acrylic bins
- Non-skid vinyl lining
- Mounts to cabinet side and rear wall
- Figure 8 door mounting brackets
- TSCA Title VI compliant



4VDO-18SC-1



**4VDOHT-15SC-1**  
Half-Tier Vanity Drawer  
(15" Version Shown)



**4VDOHT-276FLSC-1**  
Tiered Vanity Drawer  
(12" Full Access Version Shown)



For video visit:  
[rev-a-shelf.com/videos](http://rev-a-shelf.com/videos)

### Full Access Vanity Drawer w/ BLUMOTION Soft-Close

PRODUCT	DESCRIPTION	DIMS	MCO	CAB	FINISH	SLP
4VDO-267FLSC-1	Single Drawer	10-1/2" (267 mm) W x 18-11/16" (475 mm) D x 4-5/16" (110 mm) H	10-1/2" (267 mm)	FLVB12	Maple	\$186.75
4VDOT-267FLSC-1	Tiered Drawer	10-1/2" (267 mm) W x 18-11/16" (475 mm) D x 8" (203 mm) H	10-1/2" (267 mm)	FLVB12	Maple	\$290.45
4VDOHT-267FLSC-1	Half-Tiered Drawer	10-1/2" (267 mm) W x 18-11/16" (475 mm) D x 8" (203 mm) H	10-1/2" (267 mm)	FLVB12	Maple	\$277.80
4VDO-343FLSC-1	Single Drawer	13-1/2" (343 mm) W x 18-11/16" (475 mm) D x 4-5/16" (110 mm) H	13-1/2" (343 mm)	FLVB15	Maple	\$217.80
4VDOT-343FLSC-1	Tiered Drawer	13-1/2" (343 mm) W x 18-11/16" (475 mm) D x 8" (203 mm) H	13-1/2" (343 mm)	FLVB15	Maple	\$332.90
4VDOHT-343FLSC-1	Half-Tiered Drawer	13-1/2" (343 mm) W x 18-11/16" (475 mm) D x 8" (203 mm) H	13-1/2" (343 mm)	FLVB15	Maple	\$305.95
4VDO-419FLSC-1	Single Drawer	16-1/2" (419 mm) W x 18-11/16" (475 mm) D x 4-5/16" (110 mm) H	16-1/2" (419 mm)	FLVB18	Maple	\$245.65
4VDOHT-419FLSC-1	Half-Tiered Drawer	16-1/2" (419 mm) W x 18-11/16" (475 mm) D x 8" (203 mm) H	16-1/2" (419 mm)	FLVB18	Maple	\$335.95

### Face Frame Vanity Drawer w/ BLUMOTION Soft-Close

4VDO-12SC-1	Single Drawer	9" (229 mm) W x 18-11/16" (475 mm) D x 4-5/16" (110 mm) H	9" (229 mm)	VB12	Maple	\$204.60
4VDOT-12SC-1	Tiered Drawer	9" (229 mm) W x 18-11/16" (475 mm) D x 8" (203 mm) H	9" (229 mm)	VB12	Maple	\$273.45
4VDOHT-12SC-1	Half-Tiered Drawer	9" (229 mm) W x 18-11/16" (475 mm) D x 8" (203 mm) H	9" (229 mm)	VB12	Maple	\$256.65
4VDO-15SC-1	Single Drawer	12" (305 mm) W x 18-11/16" (475 mm) D x 4-5/16" (110 mm) H	12" (305 mm)	VB15	Maple	\$207.05
4VDOT-15SC-1	Tiered Drawer	12" (305 mm) W x 18-11/16" (475 mm) D x 8" (203 mm) H	12" (305 mm)	VB15	Maple	\$314.20
4VDOHT-15SC-1	Half-Tiered Drawer	12" (305 mm) W x 18-11/16" (475 mm) D x 8" (203 mm) H	12" (305 mm)	VB15	Maple	\$289.00
4VDO-18SC-1	Single Drawer	15" (381 mm) W x 18-11/16" (475 mm) D x 4-5/16" (110 mm) H	15" (381 mm)	VB18	Maple	\$235.50
4VDOT-18SC-1	Tiered Drawer	15" (381 mm) W x 18-11/16" (475 mm) D x 8" (203 mm) H	15" (381 mm)	VB18	Maple	\$349.30
4VDOHT-18SC-1	Half-Tiered Drawer	15" (381 mm) W x 18-11/16" (475 mm) D x 8" (203 mm) H	15" (381 mm)	VB18	Maple	\$319.70





SCAN FOR PRICING!

# Wood Tambour Table

## 4TT Series



- Designed for 1-1/2" face frame 24" base cabinet drawers
- Complete drawer system, just add your drawer front
- Easy installation
- Natural maple construction with semi-gloss finish
- Over-extension, 220 lb. rated, table slides (static load)
- Adds 31-3/4" counter-top space
- Mounts to cabinet drawer rail and rear wall
- Patented door mount brackets with 5" of adjustability and micro-trim adjuster (US Patent No. 8,388,076)
- TSCA Title VI compliant

4TT-2133-1



**4TT-2133-1**  
Tambour Table



### Face Frame Wood Tambour Table

PRODUCT	DESCRIPTION	DIMS	MCO	CAB	FINISH	SLP
4TT-2133-1	Tambour Table	22" (559 mm) W x 19-15/16" (506 mm) D x 4-3/4" (121 mm) H	20-1/2" (521 mm) - FF 22" (559 mm) - FL	FFB24	Maple	\$539.10

# 4DP Series

# Drawer Peg System



SCAN FOR PRICING!



4DPS-WN-3021

- Designed for 42" or smaller base cabinet drawers
- Trim-to-fit existing drawer
- Drop-in installation
- Natural maple construction with semi-gloss finish, walnut construction with satin finish or natural maple construction with sound dampening vinyl covering
- Up to (120) pre-drilled peg holes
- (9), (12) or (16) matching, press-in pegs (maple and walnut only)
- Compatible with chrome accessories (sold separately)
- TSCA Title VI compliant





SCAN FOR PRICING!



Think outside the box



Perfect for vanities



Mix and match accessories for the perfect drawer solution



**4DPS-WN-2421**  
Drawer Peg System  
(Walnut version shown)



**4DPBG-3021-1**  
Drawer Peg Board  
(Vinyl finish shown)

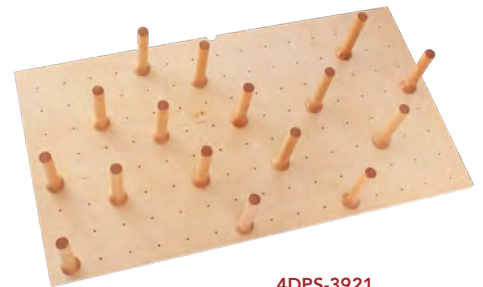

**4DPS-3921**  
Drawer Peg System  
(Maple finish shown)



**4DPS-PEG-WN-4**  
(4) Wood Pegs  
(Walnut finish shown)



**DPS-PEG-4SS**  
(4) Stainless Steel Pegs



**5DCH-2-1-CR**  
(2) Stainless Steel Containers



**5DLD-1-CR**  
Lid Organizer

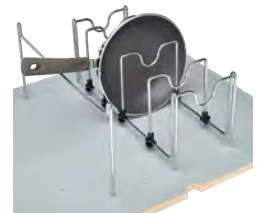

**5DCD-1-CR**  
Pot & Pan Organizer

### Drawer Peg System

PRODUCT	DESCRIPTION	DIMS	FINISH	SLP
4DPS-WN-2421	Peg System w/ (9) Pegs	24-1/4" (616 mm) W x 21-1/4" (540 mm) D x 6-5/8" (168 mm) H	Walnut	\$353.05
4DPS-WN-3021	Peg System w/ (12) Pegs	30-1/4" (768 mm) W x 21-1/4" (540 mm) D x 6-5/8" (168 mm) H	Walnut	\$455.30
4DPS-WN-3921	Peg System w/ (16) Pegs	39-1/4" (997 mm) W x 21-1/4" (540 mm) D x 6-5/8" (168 mm) H	Walnut	\$594.20
4DPS-2421	Peg System w/ (9) Pegs	24-1/4" (616 mm) W x 21-1/4" (540 mm) D x 6-5/8" (168 mm) H	Maple	\$142.10
4DPS-3021	Peg System w/ (12) Pegs	30-1/4" (768 mm) W x 21-1/4" (540 mm) D x 6-5/8" (168 mm) H	Maple	\$171.25
4DPS-3921	Peg System w/ (16) Pegs	39-1/4" (997 mm) W x 21-1/4" (540 mm) D x 6-5/8" (168 mm) H	Maple	\$222.00

### Drawer Peg Board - No Pegs

4DPBG-2421-1	Vinyl Drawer Peg Board	24-1/8" (613 mm) W x 21-1/4" (540 mm) D x 5/8" (16 mm) H	Vinyl	\$127.75
4DPBG-3021-1	Vinyl Drawer Peg Board	30-1/8" (765 mm) W x 21-1/4" (540 mm) D x 5/8" (16 mm) H	Vinyl	\$158.35
4DPBG-3921-1	Vinyl Drawer Peg Board	39-1/8" (994 mm) W x 21-1/4" (540 mm) D x 5/8" (16 mm) H	Vinyl	\$197.80
4DPB-2421	Drawer Peg Board	24-1/4" (616 mm) W x 21-1/4" (540 mm) D x 5/8" (16 mm) H	Maple	\$93.25
4DPB-3021	Drawer Peg Board	30-1/4" (769 mm) W x 21-1/4" (540 mm) D x 5/8" (16 mm) H	Maple	\$110.65
4DPB-3921	Drawer Peg Board	39-1/4" (997 mm) W x 21-1/4" (540 mm) D x 5/8" (16 mm) H	Maple	\$139.20

### Accessories

4DPS-PEG-4	(4) Maple Pegs	1-5/8" (41 mm) W x 1-5/8" (41 mm) D x 6-1/2" (165 mm) H	Maple	\$43.60
4DPS-PEG-WN-4	(4) Walnut Pegs	1-5/8" (41 mm) W x 1-5/8" (41 mm) D x 6-1/2" (165 mm) H	Walnut	\$101.00
DPS-PEG-4SS	(4) Stainless Steel Pegs	1-1/4" (32 mm) W x 1-1/4" (32 mm) D x 6" (153 mm) H	Stainless Steel	\$25.10
5DCH-2-1-CR	(2) Stainless Steel Containers	6-1/2" (165 mm) W x 10-1/4" (260 mm) D x 6-1/2" (165 mm) H	Stainless Steel	\$68.75
5DLD-1-CR	Lid Organizer	5-1/4" (133 mm) W x 16-7/8" (429 mm) D x 5-3/8" (137 mm) H	Chrome	\$35.25
5DCD-1-CR	Pot/Pan Organizer	7-3/4" (197 mm) W x 15-1/4" (387 mm) D x 7-5/8" (194 mm) H	Chrome	\$47.25



SCAN FOR PRICING!



4WCT-WN-1SH/ 4WD-22SH-WN-1

- Designed for 24" or smaller base cabinet drawers
- Trim-to-fit existing drawer
- Drop-in installation
- Natural maple construction with semi-gloss finish or walnut construction with satin finish
- Up to (9) compartments
- Shallow height sizes available
- Compatible with 4WD Wood Divider (Pg. 221) when using multiple inserts
- TSCA Title VI compliant



For video visit:  
[rev-a-shelf.com/videos](https://rev-a-shelf.com/videos)





SCAN FOR PRICING!



**4WCT-3SH**  
Wood Cutlery Tray Insert  
(Maple finish shown)



**4WCT-1SH**  
Wood Cutlery Tray Insert  
(Walnut finish shown)

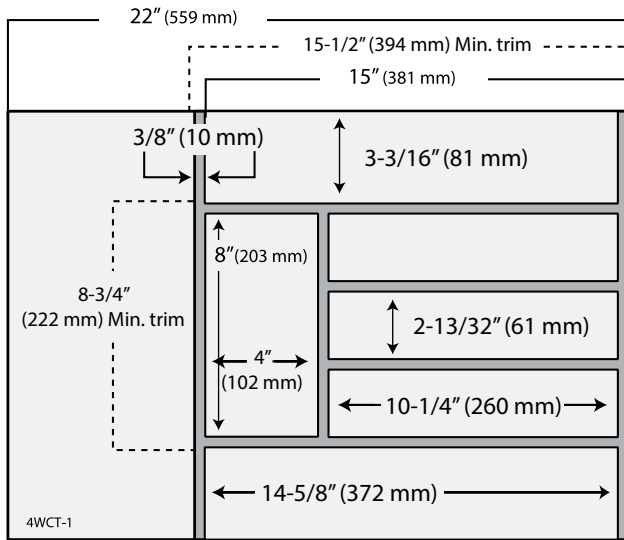

**4WCT-1**

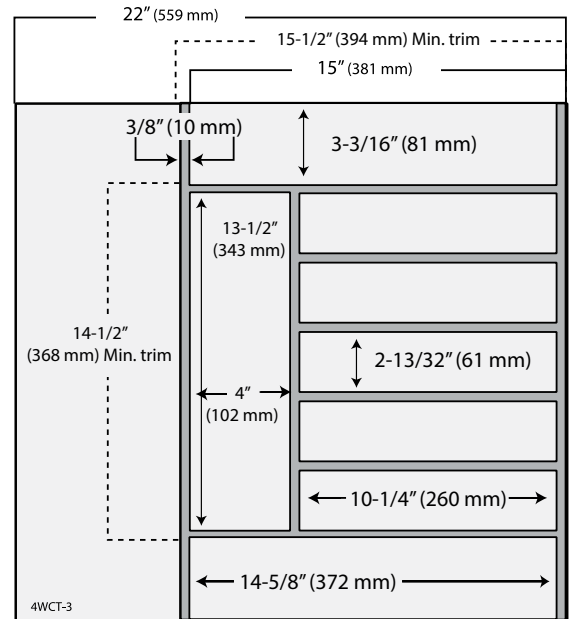

**4WCT-3**

**Shallow Wood Cutlery Tray Insert**

PRODUCT	DESCRIPTION	DIMS	FINISH	SLP
4WCT-WN-1SH	Shallow Height Cutlery Tray	15-1/8" (384 mm) W x 22" (559 mm) D x 2-3/8" (60 mm) H	Walnut	\$179.05
4WCT-WN-3SH	Shallow Height Cutlery Tray	21-1/8" (537 mm) W x 22" (559 mm) D x 2-3/8" (60 mm) H	Walnut	\$242.15
4WCT-1SH	Shallow Height Cutlery Tray	14-5/8" (371 mm) W x 22" (559 mm) D x 2-3/8" (60 mm) H	Maple	\$82.35
4WCT-3SH	Shallow Height Cutlery Tray	20-5/8" (524 mm) W x 22" (559 mm) D x 2-3/8" (60 mm) H	Maple	\$107.60

**Wood Cutlery Tray Insert**

4WCT-1	Cutlery Tray	14-5/8" (371 mm) W x 22" (559 mm) D x 2-7/8" (73 mm) H	Maple	\$98.00
4WCT-3	Cutlery Tray	20-5/8" (524 mm) W x 22" (559 mm) D x 2-7/8" (73 mm) H	Maple	\$130.35



SCAN FOR PRICING!



For video visit:  
[rev-a-shelf.com/videos](http://rev-a-shelf.com/videos)

- Designed for 36" or smaller base cabinet drawers
- Trim-to-fit existing drawer
- Drop-in installation
- Natural maple construction with semi-gloss finish or walnut construction with satin finish
- Up to (2) adjustable compartments
- Up to (12) static compartments
- Shallow height sizes available
- Compatible with 4FWI Foil Wrap Insert and 4WD Wood Divider (Pg. 221)
- TSCA Title VI compliant

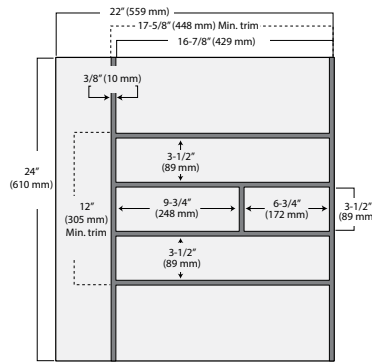

4WUT-3

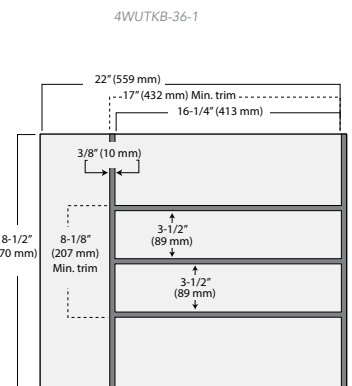

4WUT-1



4FWI-16SS-1  
 Foil Wrap Insert

Waste

Blind Corner

Sink

Base

Tall

Drawer

Wall

Vanity

Closet

Lazy Susan

LED Lighting





SCAN FOR PRICING!



**4WUT-WN-1SH**  
Wood Utensil Tray Insert  
*(Walnut finish shown)*



**4WUT-36-1**  
Wide Utensil Drawer Insert



**4WUTCT-36-1**  
Wide Utensil/Cutlery  
Drawer Insert



**4WUTKB-36-1**  
Wide Knife Block/Utensil  
Drawer Insert

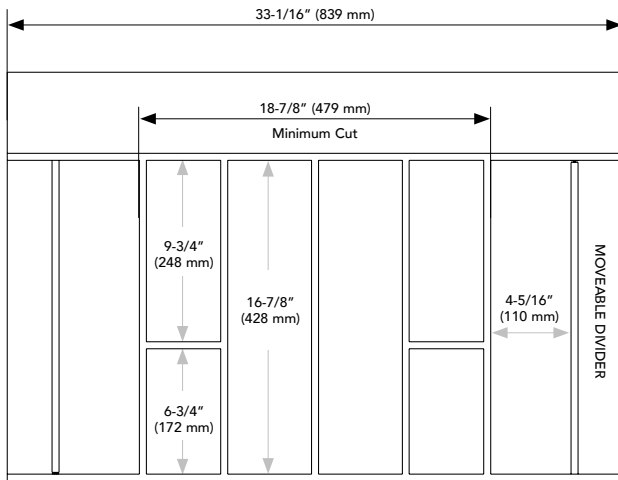

**4WUT-36-1**

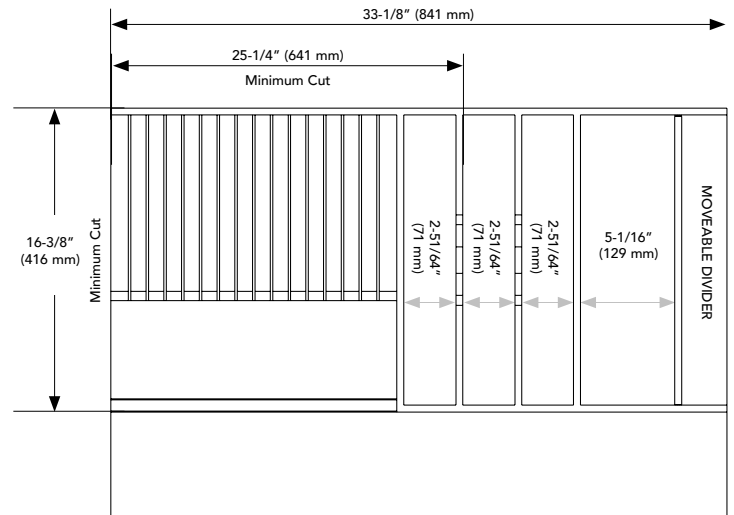

**4WUTKB-36-1**

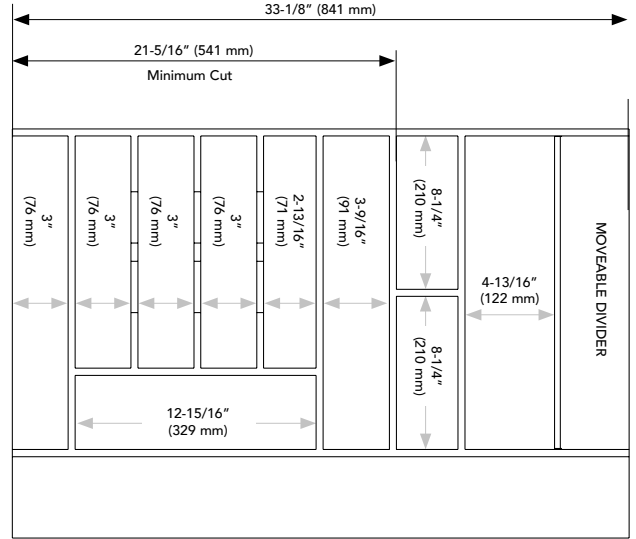

**4WUTCT-36-1**

**Shallow Wood Utensil Tray Insert**

PRODUCT	DESCRIPTION	DIMS	FINISH	SLP
4WUT-WN-1SH	Shallow Height Utensil Tray	15-1/8" (384 mm) W x 22" (559 mm) D x 2-3/8" (60 mm) H	Walnut	\$169.05
4WUT-WN-3SH	Shallow Height Utensil Tray	21-1/8" (537 mm) W x 22" (559 mm) D x 2-3/8" (60 mm) H	Walnut	\$229.10
4WUT-1SH	Shallow Height Utensil Tray	18-1/2" (470 mm) W x 22" (559 mm) D x 2-3/8" (60 mm) H	Maple	\$98.45
4WUT-3SH	Shallow Height Utensil Tray	24" (610 mm) W x 22" (559 mm) D x 2-3/8" (60 mm) H	Maple	\$120.05

**Wood Utensil Tray Insert**

4WUT-1	Utensil Tray	18-1/2" (470 mm) W x 22" (559 mm) D x 2-7/8" (73 mm) H	Maple	\$102.65
4WUT-3	Utensil Tray	24" (610 mm) W x 22" (559 mm) D x 2-7/8" (73 mm) H	Maple	\$130.80

**Wide Drawer Inserts**

4WUT-36-1	Utensil Drawer Insert	33-1/8" (841 mm) W x 22" (559 mm) D x 2-7/8" (73 mm) H	Maple	\$215.45
4WUTKB-36-1	Knife Block/Utensil Drawer Insert	33-1/8" (841 mm) W x 22" (559 mm) D x 2-7/8" (73 mm) H	Maple	\$279.55
4WUTCT-36-1	Utensil/Cutlery Drawer Insert	33-1/8" (841 mm) W x 22" (559 mm) D x 2-7/8" (73 mm) H	Maple	\$221.70

**Accessories**

4FWI-16SS-1	16" Foil Wrap Insert for 4WUT	3-7/16" (87 mm) W x 16" (406 mm) D x 2-5/8" (67 mm) H	Stainless Steel	\$43.65
-------------	-------------------------------	---	-----------------	---------

Waste  
Blind Corner  
Sink  
Base  
Tail  
Drawer  
Wall  
Vanity  
Closet  
Susan  
Lazy  
Lighting  
LED



SCAN FOR PRICING!

- Designed for 36" or smaller base cabinet drawers
- Trim-to-fit existing drawer
- Drop-in installation
- Natural maple construction with semi-gloss finish or walnut construction with satin finish
- (1) rear compartment and up to (3) tiers
- Compatible with 4WD Wood Divider (Pg. 221) when using multiple inserts
- TSCA Title VI compliant



4SDI-36-1



**4SDI-WN-18-1**  
Wood Spice Drawer Insert  
(Walnut finish shown)

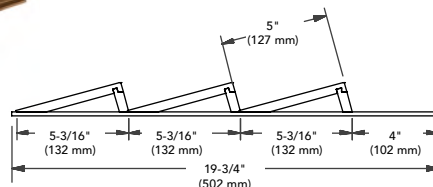

For video visit:  
[rev-a-shelf.com/videos](http://rev-a-shelf.com/videos)

### Wood Spice Drawer Insert

PRODUCT	DESCRIPTION	DIMS	FINISH	SLP
4SDI-WN-18-1	Spice Drawer Insert	16" (76 - 406 mm) W x 19-3/4" (502 mm) D x 1-17/32" (39 mm) H	Walnut	\$132.65
4SDI-WN-24-1	Spice Drawer Insert	22" (76 - 559 mm) W x 19-3/4" (502 mm) D x 1-17/32" (39 mm) H	Walnut	\$172.25
4SDI-18	Spice Drawer Insert	16" (76 - 406 mm) W x 19-3/4" (502 mm) D x 1-17/32" (39 mm) H	Maple	\$106.70
4SDI-24	Spice Drawer Insert	22" (76 - 559 mm) W x 19-3/4" (502 mm) D x 1-17/32" (39 mm) H	Maple	\$139.65

### Wide Spice Drawer Insert

4SDI-36-1	Spice Drawer Insert	33-1/8" (841 mm) W x 19-3/4" (502 mm) D x 1-3/4" (44 mm) H	Maple	\$204.75
-----------	---------------------	--	-------	----------





SCAN FOR PRICING!

# Wood K-Cup Drawer Insert

## 4CDI Series



4CDI-18-KCUP-1

- Designed for 18" and 24" base cabinet drawers
- Trim-to-fit existing drawer
- Drop-in installation
- Natural maple construction with semi-gloss finish
- Up to (4) compartments and (5) tiers that hold up to (30) K-Cups
- Compatible with 4WD Wood Divider (Pg. 221) when using multiple inserts
- TSCA Title VI compliant

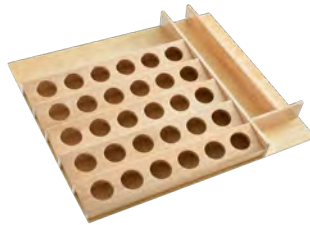

**4CDI-24-KCUP-1**  
Wood K-CUP Drawer Insert  
(24" version shown)

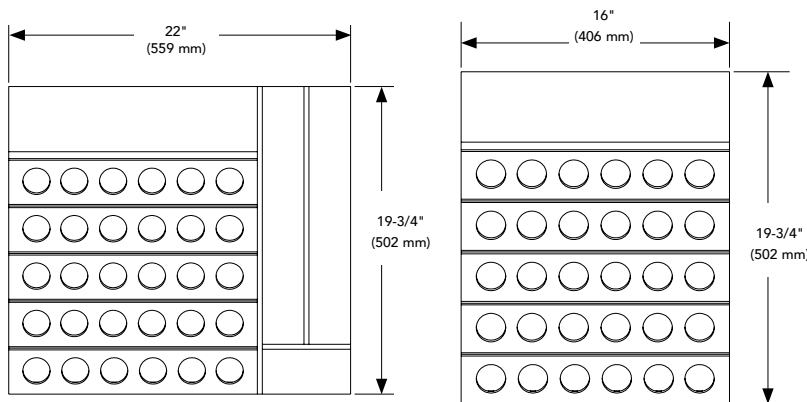

4CDI-24-KCUP-1

4CDI-18-KCUP-1



For video visit:  
[rev-a-shelf.com/videos](https://rev-a-shelf.com/videos)

### Wood K-Cup Drawer Insert

PRODUCT	DESCRIPTION	DIMS	FINISH	SLP
4CDI-18-KCUP-1	K-Cup Tray Insert	16" (406 mm) W x 19-3/4" (502 mm) D x 2-3/8" (60 mm) H	Maple	\$130.65
4CDI-24-KCUP-1	K-Cup Tray Insert	22" (559 mm) W x 19-3/4" (502 mm) D x 2-3/8" (60 mm) H	Maple	\$160.10

Waste  
Blind Corner  
Sink  
Base  
Tail  
Drawer  
Wall  
Vanity  
Closet  
Susan  
Lazy  
LED Lighting

# 4WDKB Series

## Double Knife Block Insert



SCAN FOR PRICING!

- Designed for 18-1/2" or smaller base cabinet drawers
- Trim-to-fit existing drawer
- Drop-in installation
- Natural maple construction with semi-gloss finish or walnut construction with satin finish
- (1) compartment and (2) tiers that include up to (55) knife slots
- Compatible with 4WD Wood Divider (Pg. 221) when using multiple inserts
- TSCA Title VI compliant



For video visit:  
[rev-a-shelf.com/videos](https://rev-a-shelf.com/videos)



**4WDKB-WN-1**  
 Wood Double Knife Block  
 (Walnut finish shown)

4WDKB-1

### Wood Double Knife Block Insert

PRODUCT	DESCRIPTION	DIMS	FINISH	SLP
4WDKB-WN-1	Double Knife Block Insert	18-1/2" (470 mm) W x 22" (457 - 559 mm) D x 2" (51 mm) H	Walnut	\$483.45
4WDKB-1	Double Knife Block Insert	18-1/2" (470 mm) W x 22" (457 - 559 mm) D x 2" (51 mm) H	Maple	\$170.25

# LD-4CT Series

## Adjustable Wood Drawer Organizer

- Designed for 15" and 21" base cabinet drawers
- Fits into existing drawer
- Drop-in installation
- Maple construction with semi-gloss clear finish
- Up to (13) dividers
- Customizable, press-in clips: 15" includes (18), 21" includes (26)
- TSCA Title VI compliant



LD-4CT15-1

### Wood Drawer Organizer

PRODUCT	DESCRIPTION	DIMS	FINISH	SLP
LD-4CT15-1	Drawer Organizer	9-7/8" (251 mm) W x 19-1/8" (486 mm) D x 2-1/2" (64 mm) H	Maple	\$62.20
LD-4CT21-1	Drawer Organizer	15-3/8" (391 mm) W x 19-1/8" (486 mm) D x 2-1/2" (64 mm) H	Maple	\$91.50





SCAN FOR PRICING!

# Wood Knife Block Insert

## 4WKB Series



- Designed for 18-1/2" or smaller base cabinet drawers
- Trim-to-fit existing drawer
- Drop-in installation
- Natural maple construction with semi-gloss finish
- (1) compartment and up to (19) knife slots
- Compatible with 4WD Wood Divider when using multiple inserts
- TSCA Title VI compliant

### Wood Knife Block Insert

PRODUCT	DESCRIPTION	DIMS	FINISH	SLP
4WKB-1	Knife Block Insert	18-1/2" (470 mm) W x 22" (559 mm) D x 2-3/8" (60 mm) H	Maple	\$136.30

# Wood Drawer Divider

## 4WD Series



- Designed for 22" D or smaller base cabinet drawers
- Trim-to-fit existing drawer
- Natural maple construction with semi-gloss finish or walnut construction with satin finish
- 2-3/8" shallow H or 2-7/8" H
- Compatible with 4WCT, 4WUT, 4WKB and 4SDI Inserts
- Easily combine various drawer inserts into wider drawer
- TSCA Title VI compliant

4WD-22-1

### Shallow Height Wood Drawer Divider

PRODUCT	DESCRIPTION	DIMS	FINISH	SLP
4WD-22SH-WN-1	Shallow Height Divider	1/2" (13 mm) W x 22" (559 mm) D x 2-3/8" (60 mm) H	Walnut	\$39.75
4WD-22SH-1	Shallow Height Divider	1/2" (13 mm) W x 22" (559 mm) D x 2-3/8" (60 mm) H	Maple	\$15.65

### Wood Drawer Divider

4WD-22-1	Divider	1/2" (13 mm) W x 22" (559 mm) D x 2-7/8" (73 mm) H	Maple	\$15.80
----------	---------	--	-------	---------



SCAN FOR PRICING!

- Designed for 24" or smaller base cabinet drawers
- Trim-to-fit existing drawer
- Drop-in installation
- Polystyrene construction with textured finish in white or almond, or glossy finish in white or metallic silver
- Up to (7) compartments
- Great for our outdoor applications



CT-2W-52



**CT-1A-52**  
Polymer Cutlery Tray  
*(Almond finish shown)*



**GCT-2S-52**  
Polymer Cutlery Tray  
*(Metallic Silver finish shown)*



**CT-4W-52**  
Polymer Cutlery Tray  
*(White finish shown)*

**NOTE:** Trays can be ordered trimmed to your specifications for an additional charge. Ships with a clear protective coating; remove before use.

Polymer \* - Insert (W) for White and (A) for Almond  
Glossy Polymer - \* (W) for White and (S) For Metallic Silver.

### Polymer Cutlery Tray

PRODUCT	DESCRIPTION	DIMS	MIN TRIM	FINISH	SLP
CT-1*-52	Cutlery Tray	11-1/2" (293 mm) W x 21-1/4" (540 mm) D x 2-3/8" (61 mm) H	8-5/8" (219 mm) W x 17-3/4" (451 mm) D	Polymer	\$18.40
CT-2*-52	Cutlery Tray	14-1/4" (362 mm) W x 21-1/4" (540 mm) D x 2-3/8" (61 mm) H	11-5/8" (296 mm) W x 17-3/4" (451 mm) D	Polymer	\$20.15
CT-3*-52	Cutlery Tray	17-1/2" (445 mm) W x 21-1/4" (540 mm) D x 2-3/8" (61 mm) H	14-3/4" (375 mm) W x 17-3/4" (451 mm) D	Polymer	\$23.65
CT-4*-52	Cutlery Tray	21-7/8" (556 mm) W x 21-1/4" (540 mm) D x 2-3/8" (61 mm) H	18-3/4" (467 mm) W x 17-3/4" (451 mm) D	Polymer	\$24.80
CT-1*-10	(10) Cutlery Trays	11-1/2" (293 mm) W x 21-1/4" (540 mm) D x 2-3/8" (61 mm) H	8-5/8" (219 mm) W x 17-3/4" (451 mm) D	Polymer	\$13.80 ea.
CT-2*-20	(20) Cutlery Trays	14-1/4" (362 mm) W x 21-1/4" (540 mm) D x 2-3/8" (61 mm) H	11-5/8" (296 mm) W x 17-3/4" (451 mm) D	Polymer	\$14.20 ea.
CT-3*-20	(20) Cutlery Trays	17-1/2" (445 mm) W x 21-1/4" (540 mm) D x 2-3/8" (61 mm) H	14-3/4" (375 mm) W x 17-3/4" (451 mm) D	Polymer	\$16.55 ea.
CT-4*-10	(10) Cutlery Trays	21-7/8" (556 mm) W x 21-1/4" (540 mm) D x 2-3/8" (61 mm) H	18-3/4" (467 mm) W x 17-3/4" (451 mm) D	Polymer	\$16.95 ea.

### Glossy Polymer Cutlery Tray

GCT-1*-52	Cutlery Tray	11-1/2" (293 mm) W x 21-1/4" (540 mm) D x 2-3/8" (61 mm) H	8-5/8" (219 mm) W x 17-3/4" (451 mm) D	Polymer	\$24.80
GCT-2*-52	Cutlery Tray	14-1/4" (362 mm) W x 21-1/4" (540 mm) D x 2-3/8" (61 mm) H	11-5/8" (296 mm) W x 17-3/4" (451 mm) D	Polymer	\$26.85
GCT-3*-52	Cutlery Tray	17-1/2" (445 mm) W x 21-1/4" (540 mm) D x 2-3/8" (61 mm) H	14-3/4" (375 mm) W x 17-3/4" (451 mm) D	Polymer	\$31.30
GCT-4*-52	Cutlery Tray	21-7/8" (556 mm) W x 21-1/4" (540 mm) D x 2-3/8" (61 mm) H	18-3/4" (467 mm) W x 17-3/4" (451 mm) D	Polymer	\$33.35
GCT-1*-10	(10) Cutlery Trays	11-1/2" (293 mm) W x 21-1/4" (540 mm) D x 2-3/8" (61 mm) H	8-5/8" (219 mm) W x 17-3/4" (451 mm) D	Polymer	\$17.25 ea.
GCT-2*-20	(20) Cutlery Trays	14-1/4" (362 mm) W x 21-1/4" (540 mm) D x 2-3/8" (61 mm) H	11-5/8" (296 mm) W x 17-3/4" (451 mm) D	Polymer	\$17.70 ea.
GCT-3*-20	(20) Cutlery Trays	17-1/2" (445 mm) W x 21-1/4" (540 mm) D x 2-3/8" (61 mm) H	14-3/4" (375 mm) W x 17-3/4" (451 mm) D	Polymer	\$20.60 ea.
GCT-4*-10	(10) Cutlery Trays	21-7/8" (556 mm) W x 21-1/4" (540 mm) D x 2-3/8" (61 mm) H	18-3/4" (467 mm) W x 17-3/4" (451 mm) D	Polymer	\$21.00 ea.



SCAN FOR PRICING!

# Polymer Utensil Tray

## UT/GUT Series



- Designed for 24" or smaller base cabinet drawers
- Trim-to-fit existing drawer
- Drop-in installation
- Polystyrene construction with textured or glossy finish in white, or textured finish in almond
- Up to (4) compartments
- Great for our outdoor applications

GUT-18W-52



**UT-10A-52**  
Polymer Utensil Tray  
*(Almond finish shown)*



**UT-12A-52**  
Polymer Utensil Tray  
*(Almond finish shown)*



**GUT-15W-52**  
Polymer Utensil Tray  
*(White finish shown)*

**NOTE:** Trays can be ordered trimmed to your specifications for an additional charge. Ships with a clear protective coating; remove before use.

\* - Insert (W) for White, (A) for Almond. Add "G" to the beginning of the product number to designate Glossy finish.

### Polymer Utensil Tray

PRODUCT	DESCRIPTION	DIMS	MIN TRIM	FINISH	SLP
UT-10*-52	Utensil Tray	11-1/2" (293 mm) W x 21-1/4" (540 mm) D x 2-3/8" (61 mm) H	8-5/8" (219 mm) W x 17-3/4" (451 mm) D	Polymer	\$29.15
UT-12*-52	Utensil Tray	14-1/4" (362 mm) W x 21-1/4" (540 mm) D x 2-3/8" (61 mm) H	11-5/8" (296 mm) W x 17-3/4" (451 mm) D	Polymer	\$28.00
UT-15*-52	Utensil Tray	17-1/2" (445 mm) W x 21-1/4" (540 mm) D x 2-3/8" (61 mm) H	14-3/4" (375 mm) W x 17-3/4" (451 mm) D	Polymer	\$28.40
UT-18*-52	Utensil Tray	21-7/8" (556 mm) W x 21-1/4" (540 mm) D x 2-3/8" (61 mm) H	18-3/8" (467 mm) W x 17-3/4" (451 mm) D	Polymer	\$35.50

### Polymer Utensil Trays

UT-10*-10	(10) Utensil Trays	11-1/2" (293 mm) W x 21-1/4" (540 mm) D x 2-3/8" (61 mm) H	8-5/8" (219 mm) W x 17-3/4" (451 mm) D	Polymer	\$16.40 ea.
UT-12*-20	(20) Utensil Trays	14-1/4" (362 mm) W x 21-1/4" (540 mm) D x 2-3/8" (61 mm) H	11-5/8" (296 mm) W x 17-3/4" (451 mm) D	Polymer	\$16.95 ea.
UT-15*-20	(20) Utensil Trays	17-1/2" (445 mm) W x 21-1/4" (540 mm) D x 2-3/8" (61 mm) H	14-3/4" (375 mm) W x 17-3/4" (451 mm) D	Polymer	\$19.70 ea.
UT-18*-10	(10) Utensil Trays	21-7/8" (556 mm) W x 21-1/4" (540 mm) D x 2-3/8" (61 mm) H	18-3/8" (467 mm) W x 17-3/4" (451 mm) D	Polymer	\$27.85 ea.





SCAN FOR PRICING!

- Designed for 48" or smaller base cabinet drawers
- Trim-to-fit existing drawer
- Drop-in installation
- Polystyrene construction with textured finish, almond or white
- Up to (4) tiers
- Great for our outdoor applications

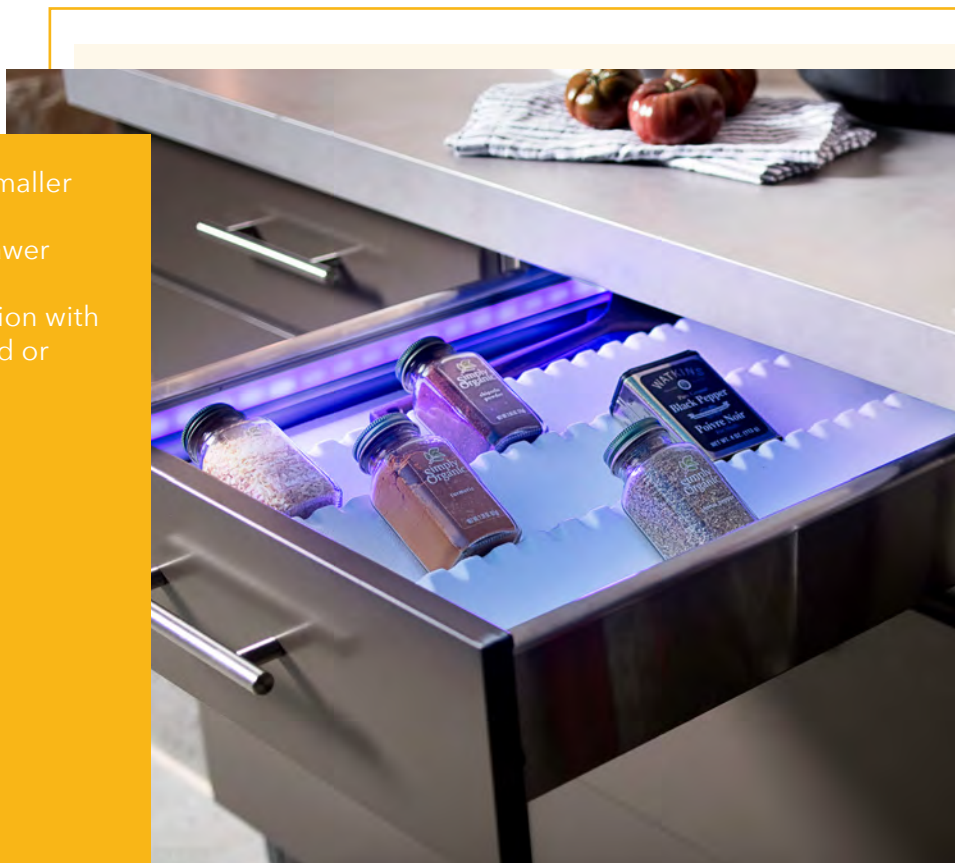

ST50-21W-52



**ST50-21A-52**  
Polymer Spice Tray  
*(Almond finish shown)*

**NOTE:** Trays can be ordered trimmed to your specifications for an additional charge. Ships with a clear protective coating; remove before use.

\* - Insert (W) for White, (A) for Almond

### Polymer Spice Tray

PRODUCT	DESCRIPTION	DIMS	FINISH	SLP
ST50-21*-52	Spice Tray	50" (1270 mm) W x 21" (534 mm) D x 1-7/8" (48 mm) H	Polymer	\$72.05
<b>(12) Polymer Spice Trays</b>				
ST50-21*-12	Spice Tray	50" (1270 mm) W x 21" (534 mm) D x 1-7/8" (48 mm) H	Polymer	\$63.80 ea.



# Bread Drawer Cover

## BDC Series

SCAN FOR PRICING!



- Designed for 24" or smaller base cabinet drawers
- Trim-to-fit existing drawer
- Easy installation
- Textured polymer available in almond, translucent or white
- Molded-in handle and rear stop
- Includes sliding rails and mounting screws

BDC-200-20



**BDC24-11**  
Polymer Bread Drawer Cover  
(White finish shown)



**BDC24-15**  
Polymer Bread Drawer Cover  
(Almond finish shown)

**NOTE:** Cover is textured to hide scratches. Product available in three colors. These bread drawer covers can be ordered custom cut to your drawer specifications.

\*\* - Insert (11) for White, (15) for Almond and (20) for Translucent (for an additional cost).

Polymer Bread Drawer Cover					
PRODUCT	DESCRIPTION	DIMS	MIN TRIM	FINISH	SLP
BDC-200-**	BDC Kit	16-3/4" (426 mm) W x 21-3/4" (553 mm) D x 3/8" (10 mm) H	11-5/8" (295 mm) x Any Depth	Polymer	\$45.10
BDC-200-20	BDC Kit-Translucent w/ Clear Rails	16-3/4" (295 - 425 mm) W x 21-3/4" (552 mm) D x 3/8" (10 mm) H	11-5/8" (295 mm) x Any Depth	Polymer	\$73.80
Polymer Bread Drawer Cover					
BDC24-**	BDC Kit	20-3/8" (518 mm) W x 21-3/4" (553 mm) D x 3/8" (10 mm) H	16-1/16" (408 mm) x Any Depth	Polymer	\$44.10
BDC24-20	BDC Kit-Translucent w/ Clear Rails	20-3/8" ( 511 mm) W x 21-3/4" (552 mm) D x 3/8" (10 mm) H	16-1/16" (408 mm) x Any Depth	Polymer	\$73.95
F-Channel Rail Kit					
CDR-21W-A	Extra White Rails			White	\$22.75
CDR-21A-A	Extra Almond Rails			Almond	\$22.75
CDR-21C-A	Extra Clear Rails			Clear	\$28.70

Waste  
Blind Corner  
Sink  
Base  
Tail  
Drawer  
Wall  
Vanity  
Closet  
Susan  
Lazy  
LED Lighting

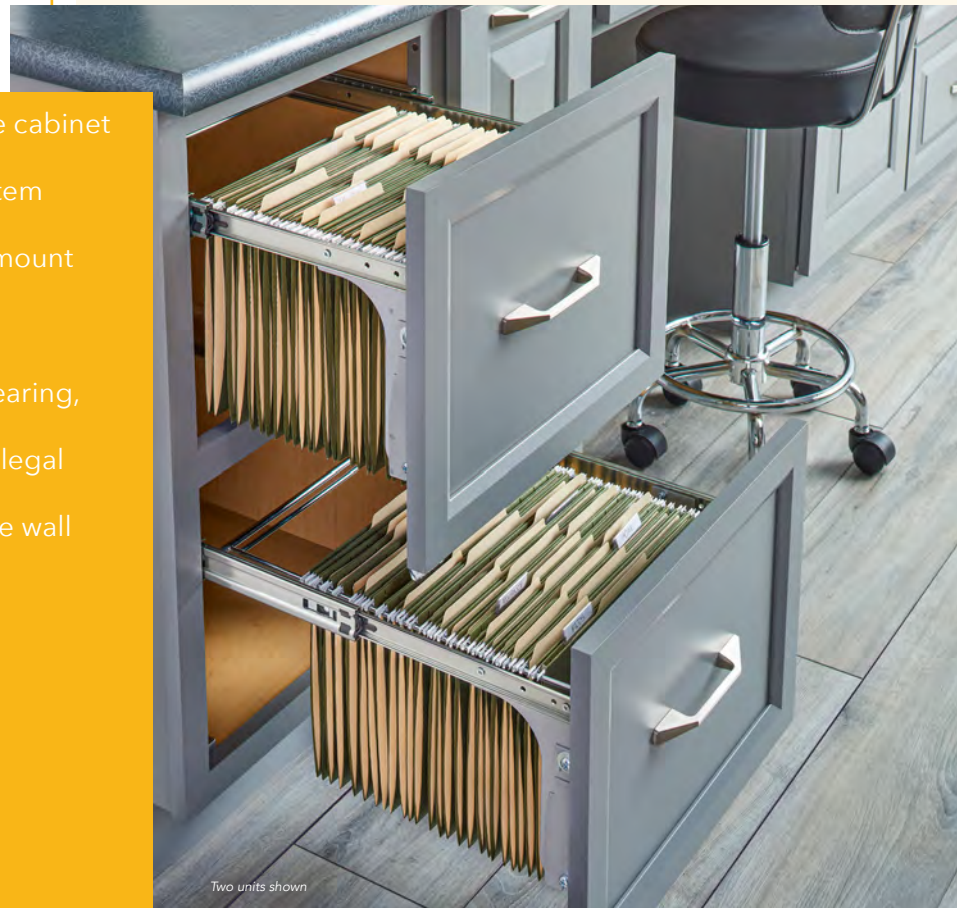

 SCAN FOR  
PRICING!

- Designed for 18" base cabinet with 1-1/2" face frame
- Complete drawer system
- Easy installation
- Pre-assembled door mount brackets
- Chrome-plated wire construction
- Full-extension, ball-bearing, 100 lb. slides
- Stores either letter or legal sizes
- Mounts to cabinet side wall

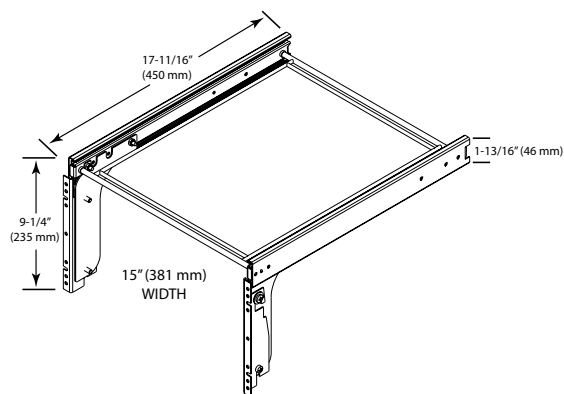

Two units shown

RAS-FDSM-DM15-1

**Pullout File Drawer System**

PRODUCT	DESCRIPTION	DIMS	MCO	CAB	FINISH	SLP
RAS-FDSM-DM15-1	Drawer System	15" (381 mm) W x 17-3/4" (451 mm) D x 10-1/2" (267 mm) H	15" (381 mm)	B18	Polymer	\$93.80





SCAN FOR PRICING!

# Two-Tier File Drawer System

## RAS-FD Series



**RAS-FD-KIT**  
Pullout File Drawer System

- Designed for a standard height base 18" drawer/door cabinet
- Features full-extension, ball-bearing slides
- Heavy duty chrome plated rails
- Can store both letter and legal folders
- Door mounting brackets (sold separately)

### Two-Tier File Drawer System

PRODUCT	DESCRIPTION	DIMS	MCO	CAB	FINISH	PRICE
RAS-FD-KIT	File Drawer System	14-3/4" (375 mm) W x 19-3/4 - 24" (502 - 610 mm) D x 22-5/8" (575 mm) H	14-1/2" (368 mm) - FF 14-7/8" (378 mm) - FL	B18	Chrome	\$168.35
RV-DM-FDKIT	(2) Door Mounting Kit				Silver	\$58.00

# File Drawer System



RAS-SMFD-52

## RAS-\*\*FD Series

- Designed for 18" and 21" base cabinet drawers
- Fits into existing drawer
- Drop-in installation
- Black, powder-coated wire construction
- RAS-LGFD includes T-rod connectors to store legal and letter sizes

### File Drawer System

PRODUCT	DESCRIPTION	DIMS	MCO	CAB	FINISH	PRICE
RAS-SMFD-52	File System-Letter	13" (330 mm) W x 19-1/4" (489 mm) D x 9-3/4" (248 mm) H	15" (381 mm)	B18	Black	\$32.20
RAS-LGFD-52	File System-Legal	15-7/8" (403 mm) W x 19-1/4" (489 mm) D x 9-3/4" (248 mm) H	18" (457 mm)	B21	Black	\$35.65

Waste  
Blind Corner  
Sink  
Base  
Tail  
Drawer  
Wall  
Vanity  
Closet  
Susan  
Lazy  
LED Lighting